



GORELTEK

PRODUCT CATALOGUE





Dear friends,

It's now been 28 years that we stand guard over your safety. During this time, we have become the No.1 manufacturer of explosion-proof equipment in Russia and successfully entered the international market. We can offer something that most companies can not - in-house R&D, custom manufacturing, integrated supplies.

Our professionals maintain smooth and efficient operation during the whole production cycle, from drawing up to on-site installation of equipment. Internal laboratory specialists conduct research and testing to ensure the highest quality of products. And the training center experts will be glad to teach you how to work with these products with steady professionalism.

In 2020 Goreltex became the exclusive distributor of R. STAHL in Russia and the Republic of Belarus. And in 2021 we significantly increased the manufacturing capacity of our production site in Tyumen, at the same time as expanding the R&D laboratory.

One thing has remained unchanged over all these years: the customer always comes first for us.

I am glad to cooperate and I am sure that our cooperation will be long-term and fruitful.

*Sincerely yours,
General Manager
"ZAVOD GORELTEX" Co. Ltd.
Y. A. Simakov*



3



production sites

8



branch offices

28



years of xperience
in explosion protection

750



employees

15⁰⁰⁰



satisfied
customers

30⁰⁰⁰



total area
of manufacturing
and technological
facilities

Mexico

Tecman
Industrial,
S.A. de C.V.

GORELTEX is the largest Russian manufacturers of modern explosion-proof electrical equipment. Our explosion-, dust-, and waterproof equipment is used at oil, chemical, gas, mining, metallurgic, defence, nuclear and other industries.

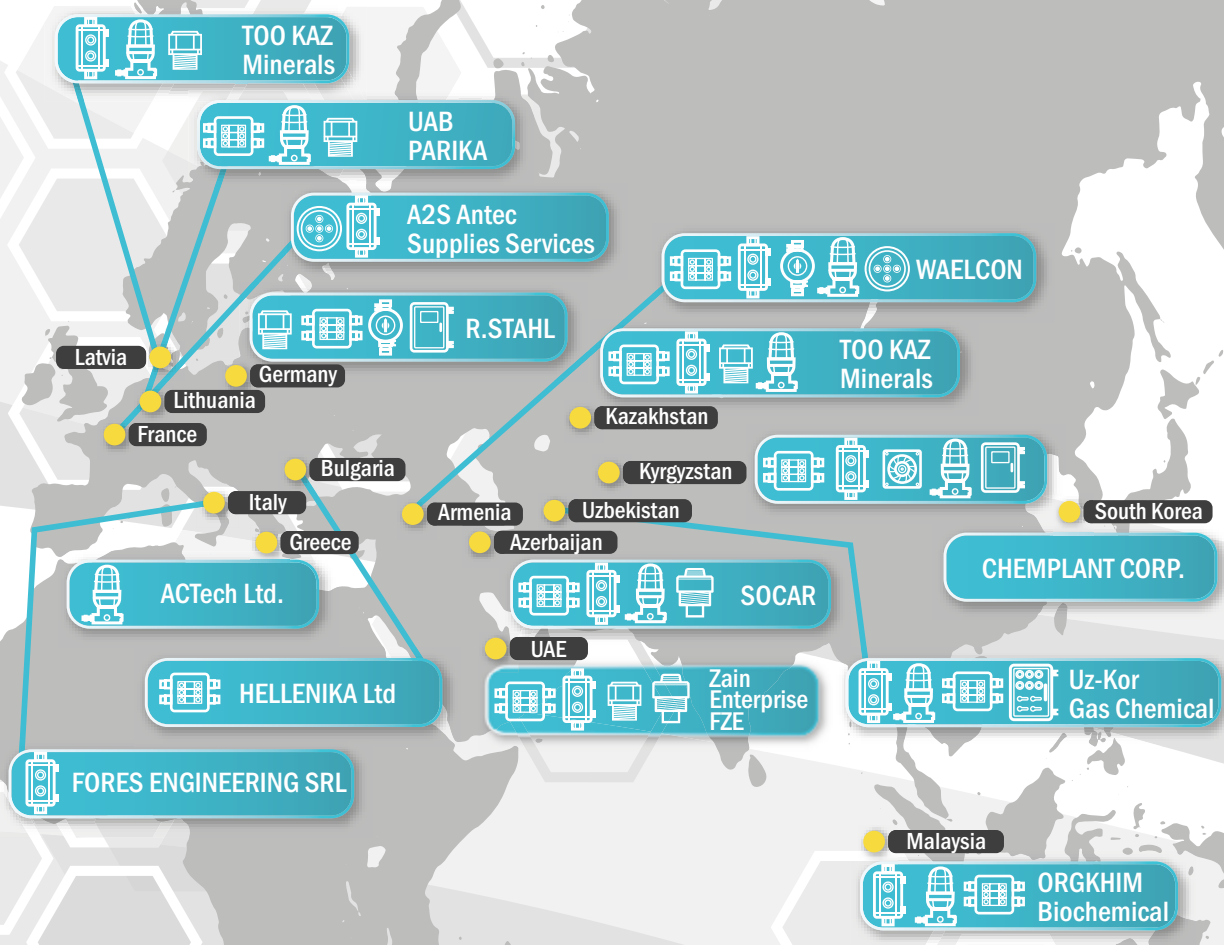



Employees. Highly skilled personnel are the basis of the equipment quality. We focus our attention on the quality of training and educating specialists to ensure operational safety of industrial facilities. Every year our employees attend professional development courses which includes both practical training of the newcomers and the advanced programs for the skilled professionals.

Laboratory. We have local engineering laboratory for research and development where the equipment is being created and tested in accordance with the international standards and certification requirements. Constant development and implementation of new technologies helps us to keep the range updated and to produce new models from modern materials. Today we give customers an opportunity to buy the products they will need tomorrow.

CAD. It is a selection software for terminal boxes, control boards, local control stations and starters. CAD is an integral system which allows to automatically create drawings of explosion-proof equipment in different options. The program does not require special skills in the engineering of explosion-proof equipment and knowledge of standards and algorithms as its main purpose is to avoid most errors. Huge possibilities of CAD allow the program to control the entire process of making blueprints, offer necessary data and automatically select the required components.

Training center. As number of inquiries for training on explosion protection is constantly growing, we decided to develop our own training program, apart from the seminars. Now you can gain extensive and structured knowledge of types of explosion protection and learn everything about product marking and current documentation at our training center.

GORELTEX manufactures and provides the following types of explosion-, dust-, and waterproof equipment:



Junction boxes



Control boards and circuit breakers



Local control stations and switchboards



Indicating, sound, signalling, light signal alarm stations



Lighting equipment



Cable glands and accessories



Other types of equipment

Our equipment is created in accordance with the international standards and certification requirements, including IECEx and ATEX certificates. You can see below some most important of them:

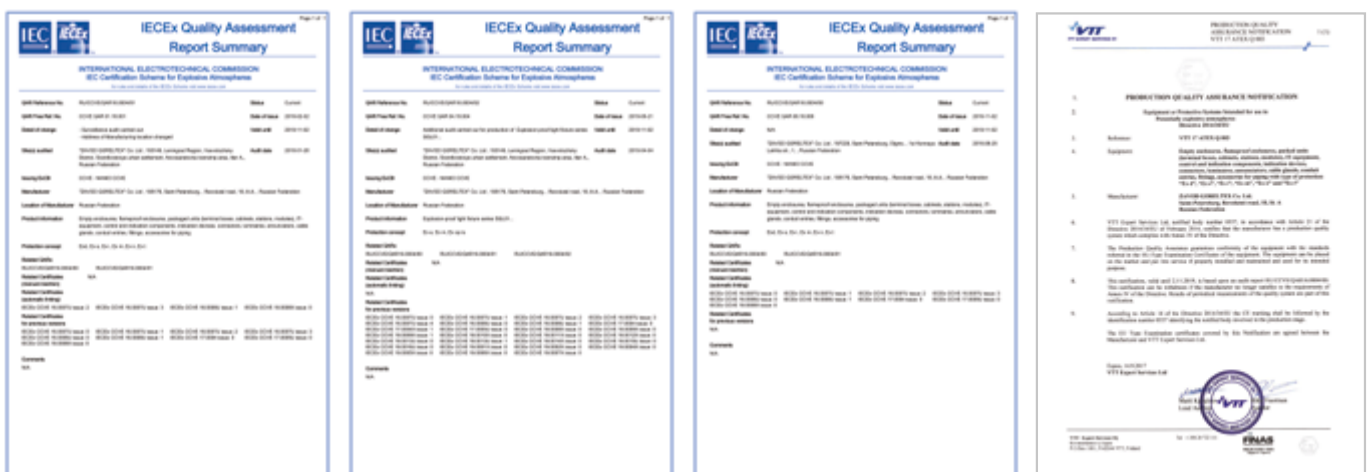

This QR code contains a link on the full certification information. To use QR code you need to point the phone camera on it.



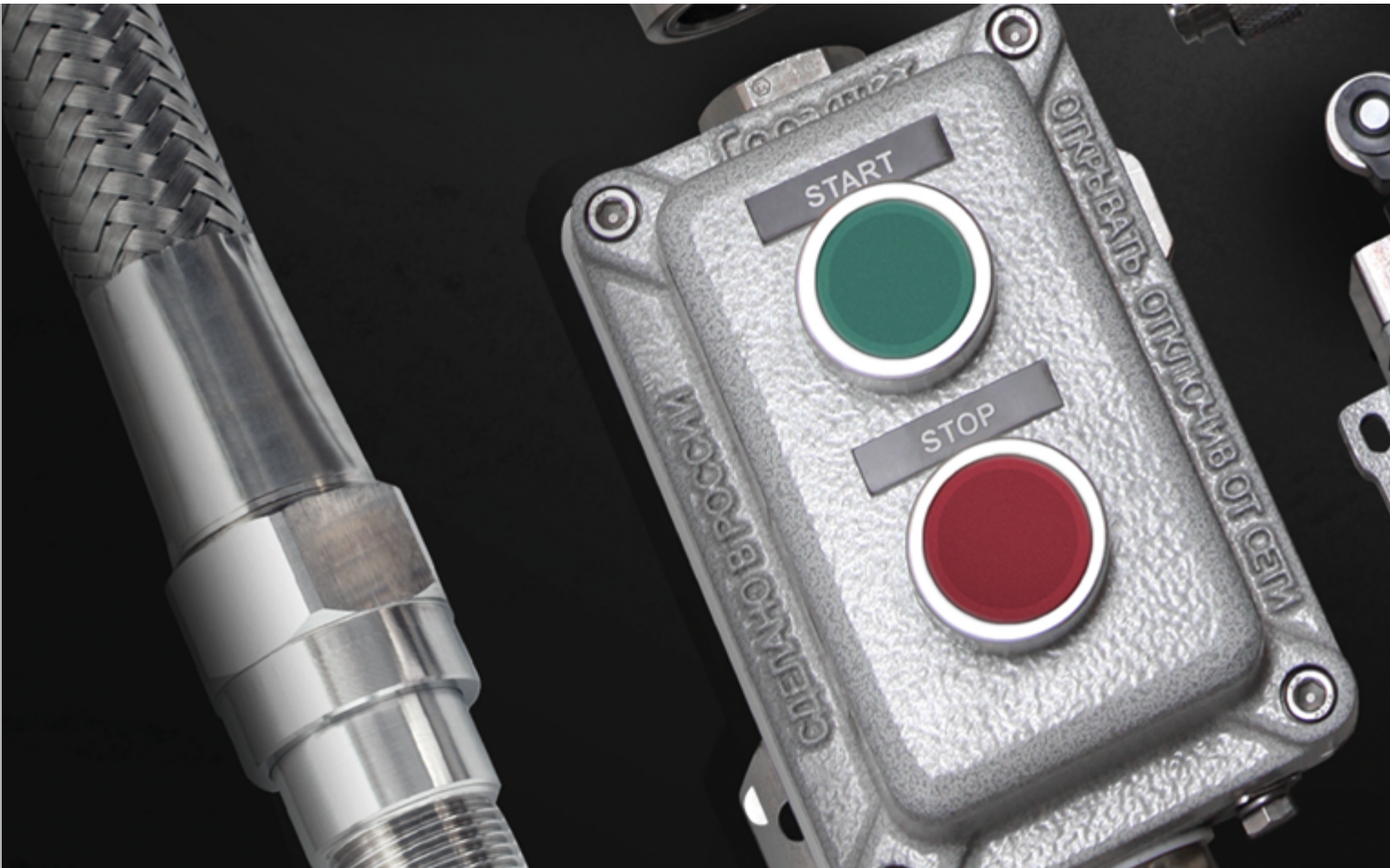

Our customers believe that the main advantage of GORELTEX is the excellent value for money and rapid delivery.

- The considerable quality of our equipment is appreciated by the leaders of oil and gas industry, e.g. Gazprom, Lukoil and Rosneft
- Local production site allows us to maintain price policy low
- Full production cycle of our equipment is carried out in the Russian Federation
- We provide the widest range of explosion-proof equipment in Russia and the CIS countries
- Customer-focused approach allows to maintain high speed of processing applications, provides technical support in the engineering explosion-proof facilities and delivers high level of warranty and post-warranty services
- Over 28-year experience in the industry allows us to automatize the production process and deliver necessary equipment to the customer in short terms
- In our laboratory the equipment is being created, updated and tested in accordance with the international standards and certification requirements
- We provide full customer support, consulting service and professional trainings for our clients with certificate issuance

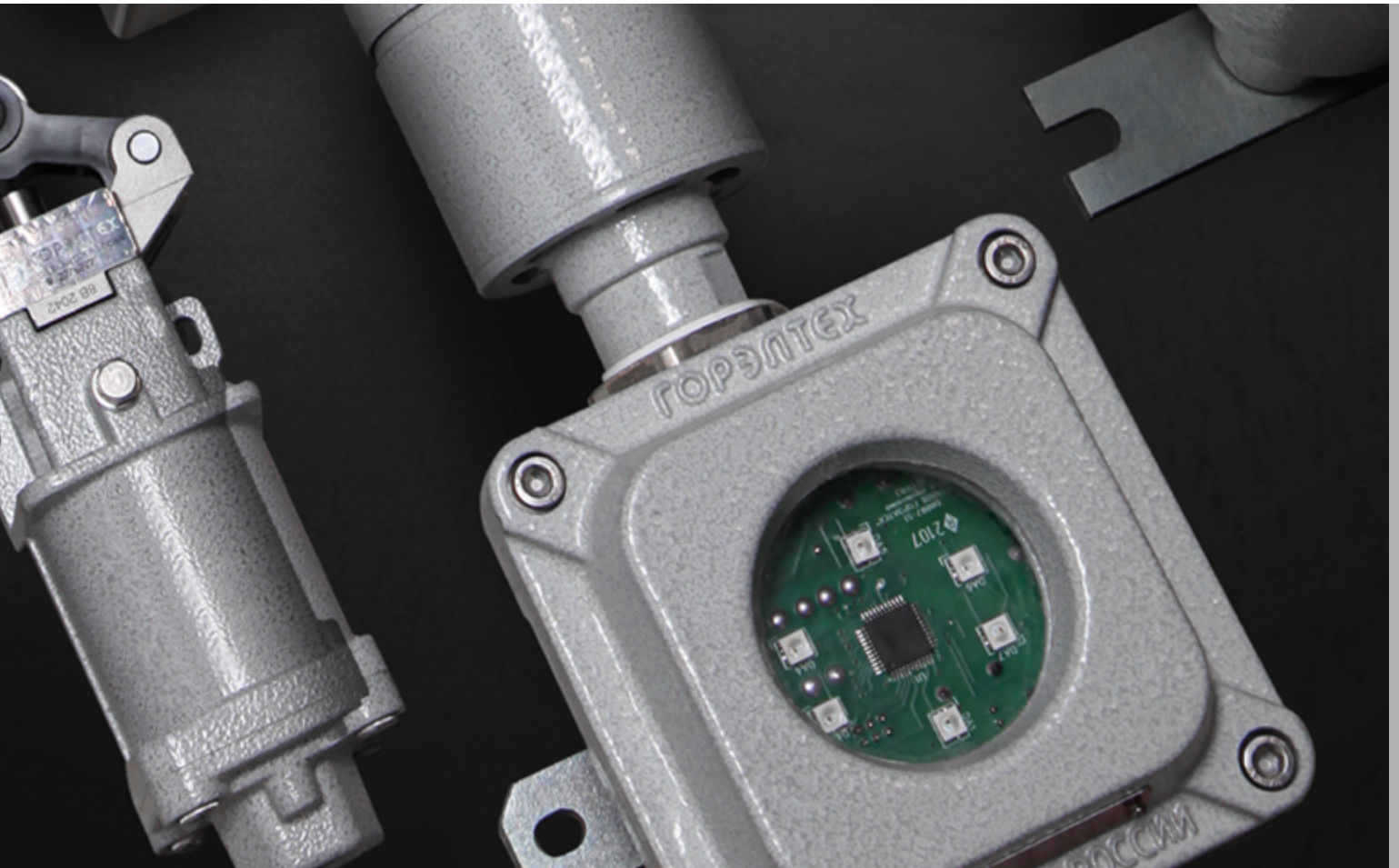

2-year warranty period



Extended warranty on request



Extended warranty if equipment is installed by our specialists



24-hour technical support service



Long lifespan of enclosures and electronic parts



Full post-sale service



Site visits of our specialists on request

Our equipment and its components is used in different projects including federal and international. We value our clients' trust and remain committed to providing the highest level of explosion protection.



NORNICKEL



ROSNEFT



ROSATOM



ТАИФ
ГРУППА КОМПАНИЙ



SURGUTNEFTEGAS
OPEN JOINT STOCK COMPANY

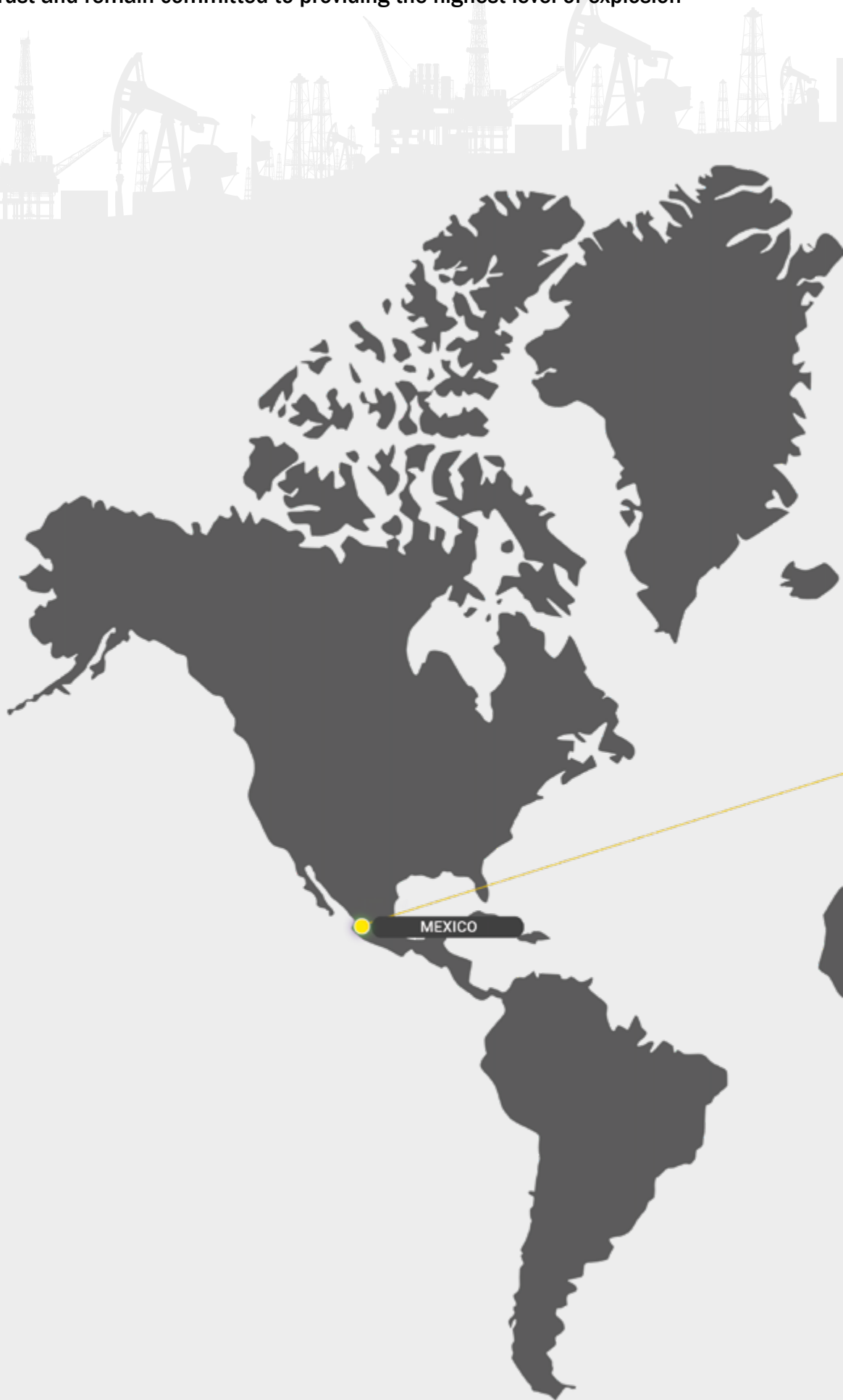



Ex d

SHORV - BASED 11
 Empty enclosures SHORV/SHORV-N/SHORV-O 18
 Junction boxes SHORV/SHORV-N/SHORV-O 21
 Local control stations PKIV/PKIV-N/PKIV-O 22
 Control boards SHGV/SHGV-N/SHGV-O 25

SHORVA - BASED 26
 Empty enclosures SHORVA/SHORVA-O 31
 Junction boxes SHORVA/SHORVA-O 33
 Local control stations PKIVA 34
 Control boards SHGVA 35

KKVA - BASED 36
 Empty enclosures KKVA 38
 Junction boxes KKVA 42

EX D Control and indicating elements 43

Ex e

KSRV - BASED 51
 Empty enclosures KSRV/KSRV-N/KSRV-M 54
 Junction boxes KSRV/KSRV-N/KSRV-M 58
 Local control stations PKIE/PKIE-N/PKIE-M 59

EX E Control and indicating elements 60

Ready solutions

Solutions for control stations 67
 Local control stations PPG 68
 Local control stations PKIVA 73
 DVG limit switches 75
 Local control stations KV-KIP 78

Lighting equipment 80
 SGJ01 acorn lamps 81
 SGL01 linear light fixtures 84
 SGU01 universal light fixture 86
 SGR07 portable light fixtures 89
 SGP05 floodlight 92

Sound and signal indication 95
 Light signaling device PGS-SIGNAL 96
 Light signaling device PGS-VSPYSHKA 98
 Light sign PGS-IT35 100
 Signaling devices PGZ-SIRENA2 102
 Light and sound alarm PGSK01 104
 Light and sound signaling device PGSK02 106
 Light and sound signaling device PGSK03 108
 Light and sound signaling device PGSK04 110
 SGA aircraft warning lights 112

Sockets and plugs 115
 RGVK sockets 116
 RGM sockets and VGM plugs 118
 RGS sockets and VGS plugs 121

Cable glands and accessories 124
 KNV cable gland 125
 KNVTV, KNVTN cable glands 128
 KOV cable gland 132
 KOVTV, KOVTN cable glands 137
 VZ blanking elements 141
 AV adapters 143
 DK drain plugs 145
 NV nipples and bushings 147
 RZ fitting joints 149
 TS fitting joints 151

Information 153



SHORV - BASED

Our own in-house development

Small mass of enclosure

Wide range of dimensions available

Manufacturing on customer specifications

CERTIFICATION DATA FOR EMPTY ENCLOSURES

Zones for installation

Zone 1 - Zone 2 (Gas)

Zone 21 - Zone 22 (Dust)

Version

IECEX	Ex db IIB+H ₂ Gb Ex tb IIIC Db		SHORV empty enclosures made of aluminium-silicon alloy with use of lubricant on flange joints
ATEX	⊕ II 2 G Ex db IIB+H ₂ Gb ⊕ II 2 D Ex tb IIIC Db		
IECEX	Ex db IIB+H ₂ Gb Ex db IIC Gb Ex tb IIIC Db		SHORV-N empty enclosures made of stainless steel with use of lubricant on flange joints
ATEX	⊕ II 2 G Ex db IIB+H ₂ Gb ⊕ II 2 G Ex db IIC Gb ⊕ II 2 D Ex tb IIIC Db		

Certification



IECEX CCVE 16.0007U

All **IECEX** and **ATEX** certification data can be downloaded from www.en.exd.ru

EESF 18 ATEX 062U

Conformance standards

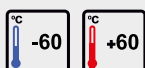
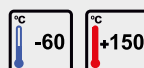
The enclosures are manufactured in accordance with the requirements of Directive 2014/34/EU ATEX standards and conform to them, IEC 60079-0: 2011, IEC 60079-1: 2014, IEC 60079-31: 2013, EN 60079-0: 2012, EN 60079-1: 2014, EN 60079-31: 2014.

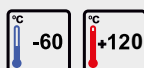
Ambient temperature. (T _{amb})	Service temperature without window (T _s)	Service temperature for emp- ty enclosures with window (T _s)	Service temperature for emp- ty enclosures with window 01515, 03212 (T _s)
			

Equipment can be used in explosive atmosphere hydrogen environment.



CERTIFICATION DATA FOR JUNCTION BOXES

Zones for installation

Zone 1 - Zone 2 (Gas)

Zone 21 - Zone 22 (Dust)

Version





IECEX	Ex db IIB+H ₂ T6...T4 Gb Ex db IIB T4...T6 Gb Ex tb IIIC T65°C... T120°C Db		SHORV... aluminum-silicon alloy junction box with lubricant on flanged joints, with terminals installed inside
ATEX	⊕ II 2 G Ex db IIB+H ₂ T4...T6 Gb ⊕ II 2 G Ex db IIB T4...T6 Gb ⊕ II 2 D Ex tb IIIC T65°C... T130°C Db		
IECEX	Ex db IIB+H ₂ T6...T4 Gb Ex db IIB T4...T6 Gb Ex tb IIIC T65°C... T120°C Db Ex db IIC T4...T6 Gb		SHORV-N... stainless steel junction box with lubricant on flanged joints, with terminals installed inside
ATEX	⊕ II 2 G Ex db IIB+H ₂ T4...T6 Gb ⊕ II 2 G Ex db IIB T4...T6 Gb ⊕ II 2 D Ex tb IIIC T65°C... T120°C Db ⊕ II 2 G Ex db IIC T4...T6 Gb		

Certification

IECEX CCVE 18.0008X

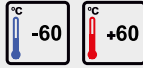
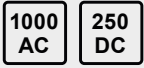
All **IECEX** and **ATEX** certification data can be downloaded from www.en.exd.ru

EESF 18 ATEX 069X

Conformance standards		
Junction boxes are manufactured in accordance with the requirements of Directive 2014/34/EU ATEX standards and conform to them, IEC 60079-0: 2011, IEC 60079-1: 2014, IEC 60079-31: 2013, EN 60079-0: 2012, EN 60079-1: 2014, EN 60079-31: 2014.		
Permissible Ambient temperature range	Maximum voltage, V	Maximum current
		
Alternating current frequency, Hz	Range of terminated wire cross-section, mm ²	
		

Special conditions of use - It is prohibited to use SHORV-N... junction boxes in mixtures of acetylene and air.

CERTIFICATION DATA FOR CONTROL STATIONS

Zones for installation	
Zone 1 - Zone 2 (Gas)	Zone 21 - Zone 22 (Dust)
Version	
IECEX Ex db IIB T6...T5 Gb Ex db IIB+H ₂ T6...T5 Gb Ex db eb mb IIB+H ₂ T6...T5 Gb Ex db eb mb IIB T6...T5 Gb Ex tb IIIC T51°C... T100°C Db	 PKIV... aluminum alloy control stations
ATEX Ⓜ II 2 G Ex db IIB T6...T5 Gb Ⓜ II 2 G Ex db IIB+H ₂ T6...T5 Gb Ⓜ II 2 G Ex db eb mb IIB+H ₂ T6...T5 Gb Ⓜ II 2 G Ex db eb mb IIB T6...T5 Gb Ⓜ II 2 D Ex tb IIIC T51°C... T100°C Db	
IECEX Ex db IIB T6...T5 Gb Ex db IIB+H ₂ T6...T5 Gb Ex db eb mb IIB+H ₂ T6...T5 Gb Ex db eb mb IIB T6...T5 Gb Ex tb IIIC T51°C... T100°C Db Ex db IIC T6...T5 Gb Ex db eb mb IIC T6...T5 Gb	 PKIV-N... stainless steel control stations
ATEX Ⓜ II 2 G Ex db IIB T6...T5 Gb Ⓜ II 2 G Ex db IIB+H ₂ T6...T5 Gb Ⓜ II 2 G Ex db eb mb IIB+H ₂ T6...T5 Gb Ⓜ II 2 G Ex db eb mb IIB T6...T5 Gb Ⓜ II 2 D Ex tb IIIC T51°C... T100°C Db Ⓜ II 2 G Ex db IIC T6...T5 Gb Ⓜ II 2 G Ex db eb mb IIC T6...T5 Gb	

Certification

IECEX CCVE 18.0009X	All IECEX and ATEX certification data can be downloaded from www.en.exd.ru
EESF 19 ATEX 029X	

Conformance standards

Control stations are manufactured in accordance with the requirements of Directive 2014/34/EU ATEX standards and conform to them, IEC 60079-0: 2011, IEC 60079-1: 2014, 60079-7:2015, IEC 60079-18:2014, IEC 60079-31: 2013, EN 60079-0: 2012, EN 60079-1: 2014, EN 60079-7:2015, EN 60079-18:2014, EN 60079-31: 2014.

Ambient temperature (T _{amb})	Alternating current frequency, Hz
	

Push button control stations, indication and signaling units can be applied in intrinsically safe circuits for circuit switching

CERTIFICATION DATA FOR CONTROL BOARDS AND CABINETS

Zones for installation	
Zone 1 - Zone 2 (Gas)	Zone 21 - Zone 22 (Dust)
Version	
IECEX	<p>Ex db IIB T6...T4 Gb Ex db eb mb IIB T6...T4 Gb Ex db IIB+H₂ T6...T4 Gb Ex db eb mb IIB+H₂ T6...T4 Gb Ex db [ia Ga] IIB T6...T4 Gb Ex db eb mb [ia Ga] IIB T6...T4 Gb Ex db [ia Ga] IIB+H₂ T6...T4 Gb Ex db eb mb [ia Ga] IIB+H₂ T6...T4 Gb Ex tb IIIC T51°C... T130°C Db</p>
ATEX	<p>⊗ II 2 G Ex db IIB T6...T4 Gb ⊗ II 2 G Ex db eb mb IIB T6...T4 Gb ⊗ II 2 G Ex db IIB+H₂ T6...T4 Gb ⊗ II 2 G Ex db eb mb IIB+H₂ T6...T4 Gb ⊗ II 2 G Ex db [ia Ga] IIB T6...T4 Gb ⊗ II 2 G Ex db eb mb [ia Ga] IIB T6...T4 Gb ⊗ II 2 G Ex db [ia Ga] IIB+H₂ T6...T4 Gb ⊗ II 2 G Ex db eb mb [ia Ga] IIB+H₂ T6...T4 Gb ⊗ II 2 G Ex tb IIIC T51°C... T130°C Db</p>
IECEX	<p>EEx db IIB T6...T4 Gb Ex db eb mb IIB T6...T4 Gb Ex db IIB+H₂ T6...T4 Gb Ex db eb mb IIB+H₂ T6...T4 Gb Ex db [ia Ga] IIB T6...T4 Gb Ex db eb mb [ia Ga] IIB T6...T4 Gb Ex db [ia Ga] IIB+H₂ T6...T4 Gb Ex db eb mb [ia Ga] IIB+H₂ T6...T4 Gb Ex tb IIIC T51°C... T130°C Db Ex db IIC T6...T4 Gb Ex db eb mb IIC T6...T4 Gb Ex db [ia Ga] IIC T6...T4 Gb Ex db eb mb [ia Ga] IIC T6...T4 Gb</p>
ATEX	<p>⊗ II 2 G Ex db IIB T6...T4 Gb ⊗ II 2 G Ex db eb mb IIB T6...T4 Gb ⊗ II 2 G Ex db IIB+H₂ T6...T4 Gb ⊗ II 2 G Ex db eb mb IIB+H₂ T6...T4 Gb ⊗ II 2 G Ex db [ia Ga] IIB T6...T4 Gb ⊗ II 2 G Ex db eb mb [ia Ga] IIB T6...T4 Gb ⊗ II 2 G Ex db [ia Ga] IIB+H₂ T6...T4 Gb ⊗ II 2 G Ex db eb mb [ia Ga] IIB+H₂ T6...T4 Gb ⊗ II 2 G Ex tb IIIC T51°C... T130°C Db ⊗ II 2 G Ex db IIC T6...T4 Gb ⊗ II 2 G Ex db eb mb IIC T6...T4 Gb ⊗ II 2 G Ex db [ia Ga] IIC T6...T4 Gb ⊗ II 2 G Ex db eb mb [ia Ga] IIC T6...T4 Gb</p>
	
SHGV... series aluminum alloy	
	
SHGV... series stainless steel control cabinets	
Certification	
IECEX CCVE 19.0007X	All IECEX and ATEX certification data can be downloaded from www.en.exd.ru
EESF 19 ATEX 073X	
Conformance standards	
Control cabinet are manufactured in accordance with the requirements of standards and conform to them, IEC 60079-0:2011, IEC 60079-1:2014, IEC 60079-7:2015, IEC 60079-11: 2011, IEC 60079-18:2014, IEC 60079-31:2013, EN 60079-0:2011, EN 60079-1:2014, EN 60079-7:2015, EN 60079-11: 2011, EN 60079-18:2014, EN 60079-31:2013.	

Permissible Ambient temperature range	Maximum voltage, V	Maximum current	Alternating current frequency, Hz
			

Marking of explosion protection is formed with consideration of components installed.

Special conditions of use: It is prohibited to use control cabinet in mixtures of acetylene and air.

TYPE AND MAXIMUM QUANTITY OF HOLES IN ENCLOSURE AND COVER OF SHORV

Dimension type of thread	Type of thread	SHORV302021/SHORV302021-01508		SHORV362821/ SHORV362821-02515/ SHORV362821-01515		SHORV362827/ SHORV362827-02515	
		A	B	A	B	A	B
02	M/NPT	12/12	6/6	15/15	12/11	21/21	16/16
01	M/NPT	12/12	6/6	15/15	12/11	21/21	16/16
1	M/NPT	12/12	6/6	15/15	11/11	21/21	16/16
2	M/NPT	9/8	5/5	11/11	8/8	18/18	12/12
3	M/NPT	6/6	4/4	8/8	6/6	13/13	9/9
4	M/NPT	5/5	2/2	6/6	5/4	9/9	6/6
5	M/NPT	3/3	1/2	4/4	3/3	6/6	5/5
6	M/NPT	2/2	1/1	3/3	2/2	6/6	4/4
7	M/NPT	2/2	1/1	2/2	1/1	3/3	2/2
8	M/NPT	1/1	1/1	2/2	1/1	2/2	1/1
9	M/NPT	1/1	1/1	1/1	1/1	2/2	1/1
10	M/NPT	1/1	1/1	1/1	1/1	2/2	1/1

Dimension type of thread	Type of thread	SHORV281811/ SHORV281813-00505		SHORV422221/ SHORV422221-02508		SHORV423229/ SHORV423229-03020	
		A	B	A	B	A	B
02	M/NPT	5/5	3/3	20(21)/20(21)	9/9	28/28	23/23
01	M/NPT	5/5	3/3	20(21)/20(21)	9/9	28/28	23/23
1	M/NPT	5/5	2/2	20/20	8/8	28/28	20/20
2	M/NPT	4/4	2/2	14/14	6/6	24/24	18/18
3	M/NPT	3/3	2/2	10/10	4/4	16/16	12/12
4	M/NPT	3/3	1/1	8/8	3/3	13(14)/13(14)	9/9
5	M/NPT	-	-	5/5	2/2	9/9	6/6
6	M/NPT	-	-	4/4	1/1	7/7	5/5
7	M/NPT	-	-	3/3	1/1	5/5	4/4
8	M/NPT	-	-	2/2	1/1	3/3	2/2
9	M/NPT	-	-	2/2	1/1	2/2	1/1
10	M/NPT	-	-	2/2	1/1	2/2	1/1

Dimension type of thread	Type of thread	SHORV423222/ SHORV423222-03020		SHORV573931/ SHORV573931-01525/ SHORV573931-03020		SHORV573926/ SHORV573926-01525/ SHORV573926-03020	
		A	B	A	B	A	B
02	M/NPT	21/21	15/15	40/40/	24/24	30/30	18/18
01	M/NPT	21/21	15/15	40/40	24/24	30/30	18/18
1	M/NPT	21/21	15/15	40/40	24/24	30/30	18/18
2	M/NPT	17/17	12/12	34/34	20/20	26/26	15/15
3	M/NPT	9(11)/9(11)	8/8	25/25	15/15	20/20	12/12
4	M/NPT	8/8	6/6	18/18	12/12	12/12	8/8
5	M/NPT	7/7	5/5	12/12	8/8	10/10	6/6
6	M/NPT	4/4	3/3	10/10	6/6	7/7	4/4
7	M/NPT	3/3	2/2	7/7	4/4	4/4	3/3
8	M/NPT	2/2	1/1	4/4	2/2	3/3	2/2
9	M/NPT	2/2	1/1	3/3	2/2	3/3	2/2
10	M/NPT	2/2	1/1	3/3	2/2	3/3	2/2

Dimension type of thread	Type of thread	SHORV654526/ SHORV654526-03020		SHORV654533/ SHORV654533-03020		SHORV725224/ SHORV725224-03020	
		A	B	A	B	A	B
02	M/NPT	33/33	21/21	48/48	30/30	28/28	18/18
01	M/NPT	33/33	21/21	48/48	30/30	28/28	18/18
1	M/NPT	32/32	20/20	48/48	30/30	28/28	18/18
2	M/NPT	23/23	14/14	39(40)/39(40)	24/24	22/22	14/14
3	M/NPT	16/16	10/10	25/25	15/15	18/18	12/12
4	M/NPT	14/14	8/8	21/21	12/12	11/11	7/7
5	M/NPT	8/8	5/5	14/14	9/9	8/8	5/5
6	M/NPT	6/6	4/4	11/11	7/7	6/6	4/4
7	M/NPT	5/5	3/3	8/8	5/5	5/5	3/3
8	M/NPT	4/4	2/2	5/5	3/3	4/4	3/3
9	M/NPT	3/3	2/2	3/3	2/2	3/3	2/2
10	M/NPT	3/3	2/2	3/3	2/2	3/3	2/2

Dimension type of thread	Type of thread	SHORV725235/ SHORV725235-03020		SHORV764323/SHORV764323-02610		SHORV896735/SHORV896735-02030/ SHORV896735-03020	
		A	B	A	B	A	B
02	M/NPT	60/60	40/40	15(17)/15(17)	8/8	56/56	40/40
01	M/NPT	60/60	40/40	15(17)/15(17)	8/8	56/56	40/40
1	M/NPT	58/58	38/38	15(17)/15(17)	8/8	56/56	40/40
2	M/NPT	44/44	28/28	12/12	6/6	39(50)/39(50)	34/34
3	M/NPT	36/36	24/24	10/10	5/5	32/32	21/21
4	M/NPT	24/24	15/15	6(9)/6(9)	4/4	20(26)/20(26)	17/17
5	M/NPT	20/20	14/14	6(9)/6(9)	4/4	16/16	12/12
6	M/NPT	14/14	9/9	-	-	14(15)/14(15)	10/10
7	M/NPT	10/10	6/6	-	-	8/8	6/6
8	M/NPT	6/6	4/4	-	-	5/5	4/4
9	M/NPT	4/4	3/3	-	-	4/4	3/3
10	M/NPT	4/4	3/3	-	-	4/4	3/3

Dimension type of thread	Type of thread	SHORV896745/ SHORV896745-02030/ SHORV896745-03020		SHORV1045839		SHORV1077740	
		A	B	A	B	A	B
02	M/NPT	84(88)/84(88)	61/61	70/70	35/35	70/70	46/46
01	M/NPT	84(88)/84(88)	61/61	70/70	35/35	70/70	46/46
1	M/NPT	84(88)/84(88)	61/61	70/70	35/35	70/70	46/46
2	M/NPT	68(75)/68(75)	51/51	62/62	28/28	62/62	40/40
3	M/NPT	50(53)/50(53)	35/35	45/45	21/21	45/45	30/30
4	M/NPT	36/36	25/25	33/33	15/15	33/33	21/21
5	M/NPT	24(28)/24(28)	20/20	23/23	11/11	23/23	15/15
6	M/NPT	21/21	15/15	18/18	8/8	18/18	12/12
7	M/NPT	15/15	11/11	14/14	5/5	14/14	9/9
8	M/NPT	10/10	6/6	7/7	3/3	7/7	5/5
9	M/NPT	8/8	6/6	5/5	2/2	5/5	3/3
10	M/NPT	7/7	5/5	5/5	2/2	5/5	3/3

TYPE AND MAXIMUM QUANTITY OF HOLES IN ENCLOSURE AND COVER OF SHORV-N

Dimension type of thread	Type of thread	SHORV-N312120		SHORV-N372926		SHORV-N281811		SHORV-N432221	
		A	B	A	B	A	B	A	B
02	M/NPT	10/10	6/6	21/21	16/16	5(6)/5(6)	3/3	21/21	10/10
01	M/NPT	10/10	6/6	21/21	16/16	5(6)/5(6)	3/3	21/21	10/10
1	M/NPT	10/10	6/6	20/20	16/16	4(5)/4(5)	3/3	21/21	9/9
2	M/NPT	8/8	5/5	18/18	12/12	4/4	2/2	18/18	8/8
3	M/NPT	6/6	4/4	12/12	9/9	3/3	2/2	12/12	5/5
4	M/NPT	6/6	2/2	9/9	6/6	3/3	1/1	10/10	4/4
5	M/NPT	4/4	2/2	6/6	4/4	-	-	7/7	3/3
6	M/NPT	2(3)/3	1/1	6/6	4/4	-	-	5/5	2/2
7	M/NPT	2/2	1/1	3/3	2/2	-	-	3/3	1/1
8	M/NPT	1/1	1/1	2/2	1/1	-	-	2/2	1/1
9	M/NPT	1/1	1/1	2/2	1/1	-	-	2/2	1/1
10	M/NPT	1/1	1/1	2/2	1/1	-	-	2/2	1/1

Dimension type of thread	Type of thread	SHORV-N563828		SHORV-N372920		SHORV-N563823		SHORV-N644433	
		A	B	A	B	A	B	A	B
02	M/NPT	45/45	28/28	18/18	12/12	27(32)/27(32)	20/20	55/55	35/35
01	M/NPT	45/45	28/28	18/18	12/12	27(32)/27(32)	20/20	55/55	35/35
1	M/NPT	43/43	28/28	15/15	12/12	27(32)/27(32)	18/18	55/55	35/35
2	M/NPT	35/35	20/20	14/14	8/8	26/26	15/15	42/42	30/30
3	M/NPT	22(25)/22(25)	14/14	8/8	6/6	15(20)/15(20)	12/12	36/36	24/24
4	M/NPT	18/18	12/12	6/6	5/5	12/12	8/8	27/27	14/14
5	M/NPT	15/15	8/8	5/5	3/3	10/10	6/6	18/18	12/12
6	M/NPT	10/10	6/6	3/3	2/2	7(9)/7(9)	5/5	15/15	9/9
7	M/NPT	7(8)/7(8)	4/4	2/2	2/2	4/4	3/3	9/9	6/6
8	M/NPT	4/4	2/2	2/2	1/1	3/3	2/2	8/8	4/4
9	M/NPT	3/3	2/2	1/1	1/1	3/3	2/2	4/4	3/3
10	M/NPT	3/3	2/2	1/1	1/1	3/3	2/2	4/4	2/2



SHORV

- Our own in-house development
- Small mass of enclosure
- Wide range of dimensions available
- Large volumes available (>50 dm³)
- Manufacturing on customer specifications
- Tested in conditions up to -60°C
- Full assistance in enclosure selection
- Full assistance in AutoCad

SHORV-N

- Ambient temperature -60...+60°C
- Solid-cast construction
- Lifespan more than 30 years Applicable for IIC Ex class (except acetylene atmospheres)
- Manufacturing on customer specifications
- Highly resistant to alkali, hydrochloric and sulfuric acid
- Every enclosure is tested in accordance with the international standards and certification requirements

MATERIALS

- The enclosure and cover are made of aluminium-silicon alloy with magnesium content of at most 1% or manufactured of stainless steel (SHORV-N enclosures). The fixing bolts of the cover as well as internal and external earthing bolts are produced of stainless steel.
- The coating for the enclosures made of aluminium-silicon alloy: powder paint.
- Tempered glass of standard sizes can be used in the products.

TABLE OF DIMENSIONS

Dimension type of enclosure	Dimensions, mm														
	External			Internal					Standard fastening			Fastening with brackets			Standard dimension of window
	A	B	C	a	b	c	S	S1	d	e	f	D	E	F	L × M × H
SHORV302021	304	204	211	240	140	163	14	14	230	130	M8	230	210	9	-
SHORV302021-01508	304	204	211	240	140	150	-	14	230	130	M8	230	210	9	150×80×15
SHORV362827	364	284	275	300	220	217	20	14	290	210	M8	290	290	9	-
SHORV362827-02515	364	284		300	220	203	-	14	290	210	M8	290	290	9	250×150×19
SHORV362821	364	284	215	300	220	157	20	14	290	210	M8	290	290	9	-
SHORV362821-01515	364	284	215	300	220	147	-	14	290	210	M8	290	290	9	155×155×19
SHORV362821-02515	364	284	215	300	220	143	-	14	290	210	M8	290	290	9	250×150×19
SHORV281811	282	182	118	212	112	74	14	14	160	124	M6	160	155	9	-
SHORV281813-00505	282	182	135	212	112	89	-	14	160	124	M6	160	155	9	50×50×12
SHORV422221	424	224	213	359	159	165	15	14	350	150	M8	350	230	9	-
SHORV422221-02508	424	224	213	359	159	150	-	14	350	150	M8	350	230	9	250×80×15
SHORV423229	433	333	295	361	261	235	20	14	350	250	M10	350	330	11	-
SHORV423229-03020	433	333	295	361	261	221	-	14	350	250	M10	350	330	11	300×200×19
SHORV423222	433	333	224	361	261	165	20	14	350	250	M10	350	330	11	-
SHORV423222-03020	433	333	224	361	261	151	-	14	350	250	M10	350	330	11	300×200×19
SHORV573931	574	394	318	491	311	249	24	20	360	236	M10	360	376	11	-
SHORV573931-01525	574	394	318	491	311	240	-	20	360	236	M10	360	376	11	150×250×19
SHORV573931-03020	574	394	321	491	311	234	-	20	360	236	M10	360	376	11	300×200×19
SHORV573926	574	394	268	491	311	199	24	19	360	236	M10	360	376	11	-
SHORV573926-01525	574	394	268	491	311	190	-	19	360	236	M10	360	376	11	150×250×19
SHORV573926-03020	574	394	271	491	311	184	-	19	360	236	M10	360	376	11	300×200×19
SHORV654526	650	450	265	570	370	150	16	16	550	350	M10	550	446	11	-
SHORV654526-03020	650	450	265	570	370	183	-	16	550	350	M10	550	446	11	300×200×19

Dimension type of enclosure	Dimensions, mm														
	External			Internal					Standard fastening			Fastening with brackets			Standard dimension of window
	A	B	C	a	b	c	S	S1	d	e	f	D	E	F	L × M × H
SHORV654533	650	450	337	570	370	222	16	17,5	550	350	M10	550	446	11	-
SHORV654533-03020	650	450	337	570	370	255	-	17	550	350	M10	550	446	11	300×200×19
SHORV725224	723	523	249	639	439	136	23	17	600	400	M10	600	505	11	-
SHORV725224-03020	723	523	249	639	439	159	-	17	600	400	M10	600	505	11	300×200×19
SHORV725235	723	523	359	639	439	246	23	18,5	600	400	M10	600	505	11	-
SHORV725235-03020	723	523	359	639	439	269	-	18,5	600	400	M10	600	505	11	300×200×19
SHORV764323	768	431	233	685	348	164	20	19	580	240	M10	580	410	11	-
SHORV764323-02610	768	431	233	685	348	144	-	19	580	240	M10	580	410	11	260×100×19
SHORV896735	891	671	355	776	556	274	23	28	680	480	M16	680	640	14	-
SHORV896735-02030	891	671	355	776	556	255	-	28	680	480	M16	680	640	14	300×200×19
SHORV896735-03020	891	671	355	776	556	255	-	28	680	480	M16	680	640	14	300×200×19
SHORV896745	891	671	455	776	556	374	23	29	680	480	M16	680	640	14	-
SHORV896745-02030	891	671	455	776	556	355	-	29	680	480	M16	680	640	14	300×200×19
SHORV896745-03020	891	671	455	776	556	355	-	29	680	480	M16	680	640	14	300×200×19
SHORV1045839	1040	585	393	910	455	315	24	24	790	360	M16	790	530	16	-
SHORV1077740	1070	770	404	920	620	314	30	24	810	510	M16	810	700	16	-
SHORV-N312120	308	208	197	240	140	153	11	15,5	230	130	M8	230	210	9	-
SHORV-N372926	370	289	268	305	224	221	12,5	15,5	290	210	M10	290	290	11	-
SHORV-N281811	286	185	118	214	114	79,5	12,5	15,5	160	123,5	M8	160	171	11	-
SHORV-N432221	430	229	215	365	164	168	12,5	15,5	350	150	M10	350	230	11	-
SHORV-N563828	568	387	287	495	315	234	15,5	15,5	360	236	M10	360	376	11	-
SHORV-N372920	370	289	208	305	224	161	12,5	15,5	290	210	M10	290	290	11	-
SHORV-N563823	568	387	237	495	315	184	15,5	15,5	360	236	M10	360	376	11	-
SHORV-N644433	641	441	339	565	364	273	20	16,5	400	280	M12	400	440	14	-

DESIGN PARAMETERS

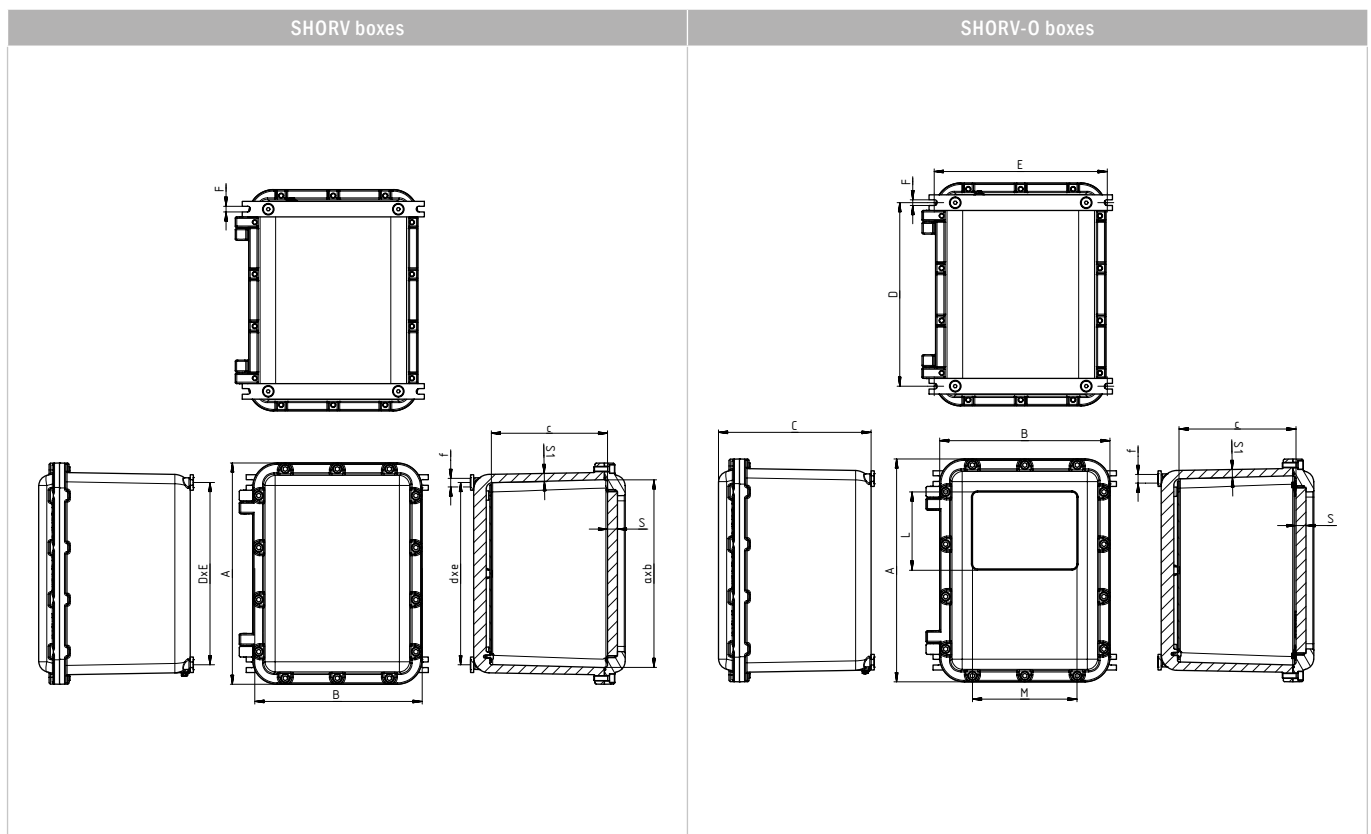

SHORV-N boxes

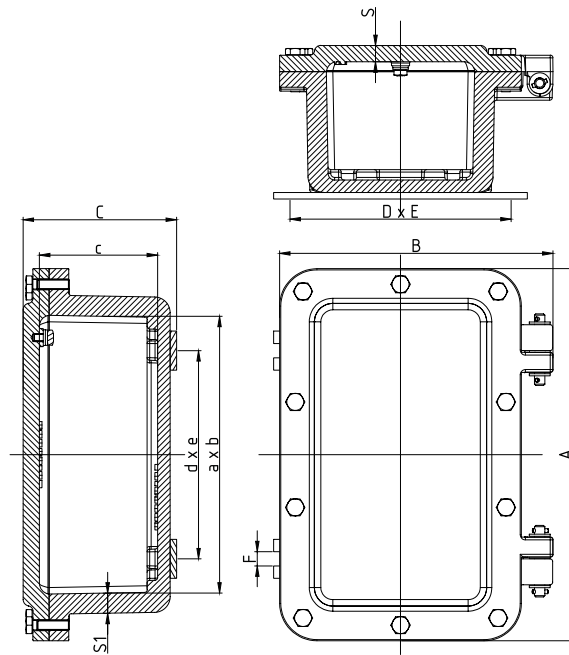

FORMATION OF MARKING

Empty enclosures type SHORV...:

SHORV X2 X3 - X4

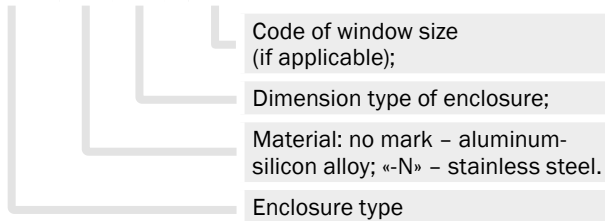

Codes of window sizes:

Enclosure type	Code of window size
SHORV...	00505
	01508
	01515
	02508
	01525
	02030
	02515
	02610
03020	

Code of window size characterizes position of window relative to the long side of product's enclosure (for rectangular windows).



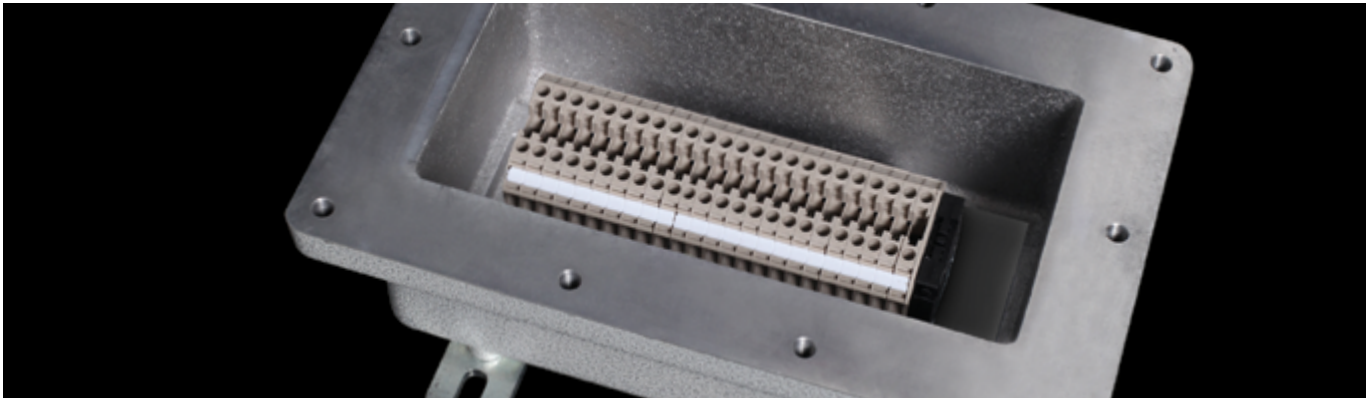

SHORV

- Lifespan of the explosion-proof cover is over 25 years
- Aluminum alloy provides high resistance to the exposure of hydrogen sulfide
- Wide range of dimensions available
- Tested in conditions up to -60°C
- Uncolored internal surface increases thermal conductivity
- Can be manufactured with window (see SHORV-O)
- Can be manufactured from highly corrosion-resistant stainless chrome-nickel casting steel (see SHORV-N)

SHORV-N

- The unique shape and external flanges provide easy access to the contents
- Seamless solid construction allows to extend life span for more than 30 years
- Molded enclosure causes no weld corrosion which often occurs in products welded from several parts
- Produced in 2 versions: standard IP66 protection degree and advanced IP67 protection degree
- Advanced IP67 boxes are upgraded with a silicone sealant rimmed in the cover's flange
- Molding technology allows to increase dimensional stability and deformation resistance so to achieve requirements for IIC explosion protection class (except acetylene atmospheres)

MAXIMUM CURRENT OF INSTALLED TERMINAL CLAMPS

Type of enclosure	Rated wire cross-section, mm ²													
	1	1,5	2,5	4	6	10	16	25, 35	50	70	95	120	150	185, 210
Rated current, A	10,1	13,1	18	24	30,7	42,7	57	93,7	127,5	167	204,1	239,4	278,1	377,6
Max. rated current, A	13,5	17,5	24	32	41	57	76	125	150	192	232	269	309	415



Cable glands available on page 124



Ex d control and indicating elements available on page 43



For the drilling data refer to page 15

FORMATION OF MARKING

Individual marking plates are applied to the junction boxes, which contain as minimum:

- product type;
- name of the manufacturer or its registered trademark;
- European conformity mark with certification body number;
- Ex-marking;
- serial number;
- ambient temperature range;
- number(s) of the certificates or a logo of the body;
- electric parameters;

and other functional data required by regulatory and technical documentation, which shall be specified in the marking by the manufacturer.

Structure of designation of SHORV and SHORV-N junction boxes:

SHORVX2(X3X4-X3X4) – X5X6(X7) – X5X6(X7)/X8, where

- └ «SHORV» – product name;
- └ «X2» – code of size of product's enclosure;
- └ «X3» – number of terminal clamps (if any);
- └ «X4» – type of terminal clamp (if any);
- └ «X5» – number of cable glands (if any);
- └ «X6» – type of cable gland (if any);
- └ «X7» – side of cable gland location (if any);
- └ «X8» – options, accessories and versions (refer to table «Designation of options, accessories, version and its description».



- Flexible system of modulation based on one-, two-, three- or multi-button enclosures
- Ultra-high mechanical and corrosion resistance of explosion-proof pins in control elements
- Easily replaceable contact modules and light sources
- Highly resistant to hydrogen sulfide exposure
- Lifespan of the flameproof joint is over 25 years

TECHNICAL CHARACTERISTICS

Product name	Maximum voltage, V*	Maximum operating current, A
PKIV... on the base of SHORV..., enclosures	1000 AC 400 DC	300 A

THE QUANTITY OF HOLES IN THE COVER

Type of enclosure	Metric thread						Straight thread*					
	Dimension type of thread											
	02	01	1	2	3	4	02	01	1	2	3	4
SHORV302021	15	15	13	8	8	6	15	15	13	8	8	6
SHORV362821	34	34	29	20	15	12	34	34	27	20	15	12
SHORV362821-01515	13	13	9	7	6	4	13	13	9	7	6	4
SHORV362827	34	34	29	20	15	12	34	34	27	20	15	12
SHORV281811	18	18	15	12	8	6	18	18	15	12	8	6
SHORV281813-00505	11	11	9	8	4	4	11	11	9	8	4	4
SHORV422221	27	27	24	20	16	10	27	27	24	20	16	10
SHORV423229	47	47	40	30	24	20	47	47	40	30	24	20
SHORV423222	47	47	40	30	24	20	47	47	40	30	24	20
SHORV573931	80	80	64	54	38	32	80	80	64	54	38	32
SHORV573931-01525	40	40	30	23	19	12	40	40	30	23	19	12
SHORV573931-03020	21	21	20	14	10	9	21	21	20	14	10	9
SHORV573926	80	80	64	54	38	32	80	80	64	54	38	32
SHORV573926-01525	40	40	30	23	19	12	40	40	30	23	19	12
SHORV573926-03020	21	21	20	14	10	9	21	21	20	14	10	9
SHORV654526	98	98	70	60	43	35	98	98	70	60	43	35
SHORV654526-03020	53	53	42	32	28	20	53	53	42	32	28	20
SHORV654533	98	98	70	60	43	35	98	98	70	60	43	35
SHORV654533-03020	53	53	42	32	28	20	53	53	42	32	28	20
SHORV725224	108	108	96	84	63	43	108	108	96	84	63	43
SHORV725224-03020	63	63	52	40	33	24	63	63	52	40	33	24
SHORV725235	108	108	96	84	63	43	108	108	96	84	63	43
SHORV725235-03020	63	63	52	40	33	24	63	63	52	40	33	24
SHORV764323	98	98	84	56	43	35	98	98	84	56	43	35
SHORV764323-02610	66	66	57	52	37	29	66	66	57	52	37	29
SHORV896735	180	180	160	117	88	70	180	180	160	117	88	70
SHORV896735-03020	129	129	105	79	60	44	129	129	105	79	60	44
SHORV896735-02030	127	127	94	82	65	49	127	127	94	82	65	49
SHORV896745	180	180	160	117	88	70	180	180	160	117	88	70

Type of enclosure	Metric thread						Straight thread*					
	Dimension type of thread											
	02	01	1	2	3	4	02	01	1	2	3	4
SHORV896745-03020	129	129	105	79	60	44	129	129	105	79	60	44
SHORV896745-02030	127	127	94	82	65	49	127	127	94	82	65	49
SHORV1045839	189	189	144	126	94	78	189	189	144	126	94	78
SHORV1077740	244	244	216	162	110	84	244	244	216	162	110	84
SHORV-N312120	18	18	15	10	8	8	18	18	15	10	8	7
SHORV-N372926	34	34	26	24	15	14	34	34	29	24	17	14
SHORV-N281811	18	18	15	12	8	6	18	18	15	12	8	
SHORV-N432221	31	31	26	20	16	12	31	31	26	20	16	12
SHORV-N563828	83	83	72	56	40	35	83	83	72	56	40	35
SHORV-N372920	34	34	26	24	15	14	34	34	29	24	17	14
SHORV-N563823	83	83	72	56	40	35	83	83	72	56	40	35
SHORV-N644433	119	119	95	73	57	44	119	119	95	73	57	44

*Pipe cylindrical thread G is applicable only for products with explosion protection marking Ex tb IIIC Db



Cable glands available on page 124



Ex d control and indicating elements available on page 43



For the drilling data refer to page 15

STRUCTURAL PARAMETERS

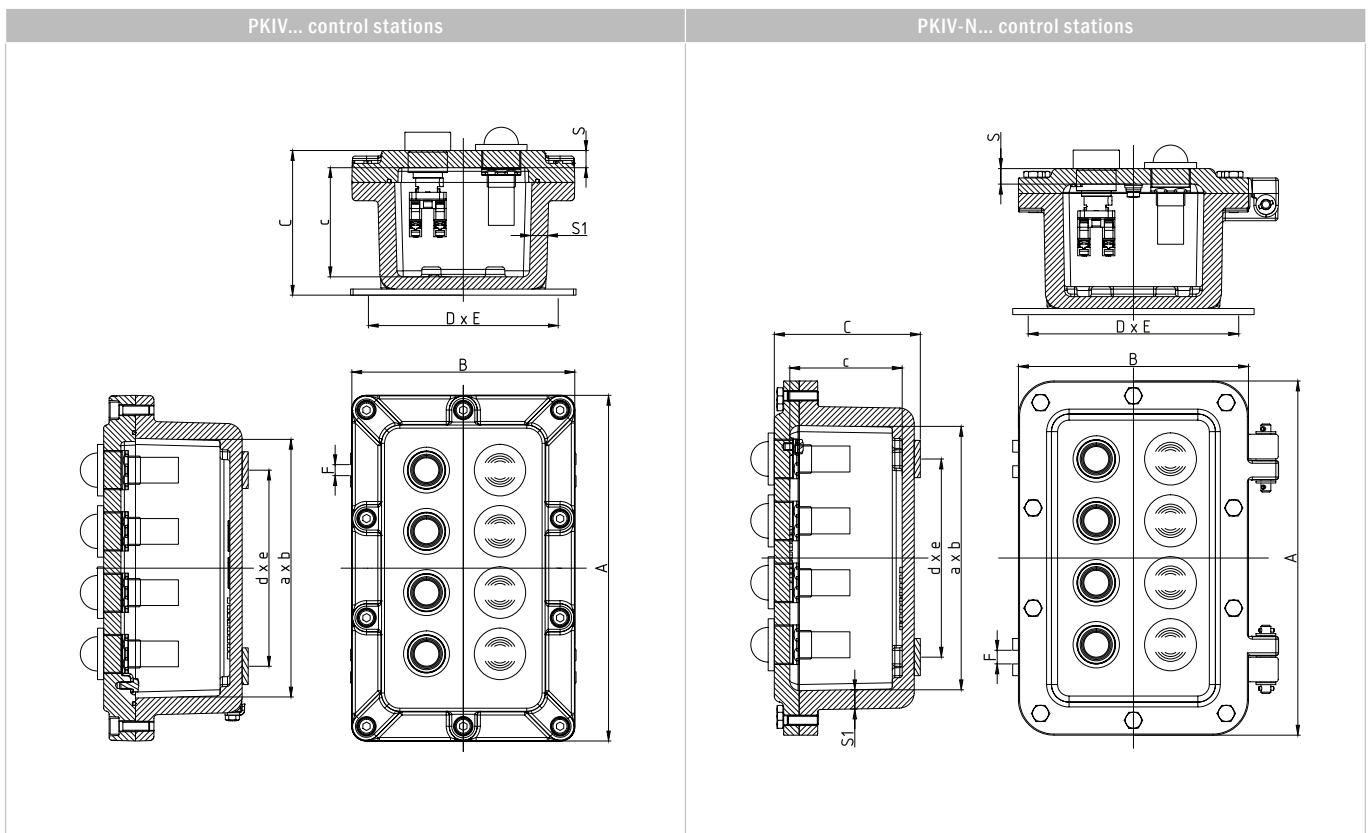

PKIV-O... control stations

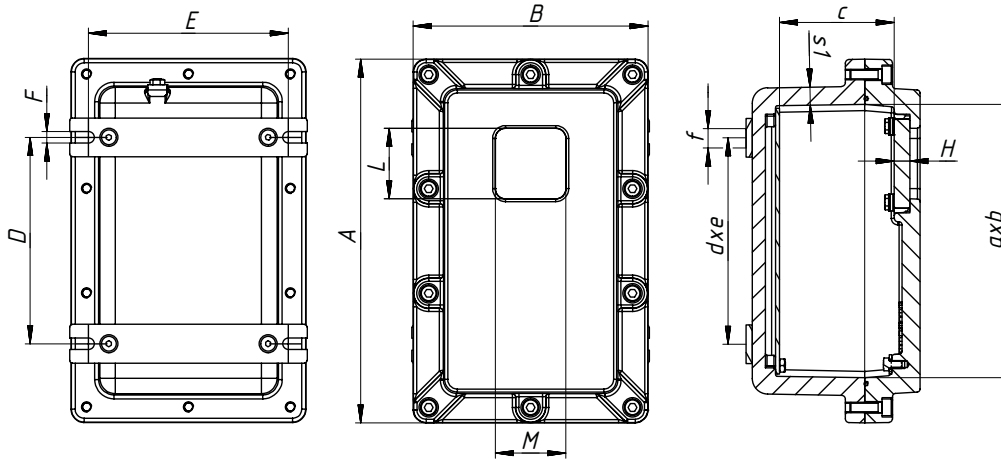

FORMATION OF MARKING

Individual marking plates are applied to the control stations, which contain as minimum:

- product name;
- name of the manufacturer or its registered trademark;
- European conformity mark with certification body number;
- Ex-marking;
- serial number;
- ambient temperature range;
- number(s) of the certificates or a logo of the body;
- electric parameters;

and other functional data required by regulatory and technical documentation, which shall be specified in the marking by the manufacturer.

Structure of designation of PKIV... control stations:

PKIVX2X3 - X4 - X5X6 - X5X6 - ... - X7X8 - X7X8 - ... / X9,
where

- └ «PKIV» - product name;
- └ «X2» - material: no mark - aluminum alloy; «-N» - stainless steel;
- └ «X3» - code of size of product's enclosure;
- └ «X4» - code of window size (for products with window, if any);
- └ «X5» - number of control element (if any);
- └ «X6» - type of control element (if any);
- └ «X7» - number of cable glands (if any);
- └ «X8» - type of cable gland (if any);
- └ «X9» - options, accessories and versions (refer to table «Designation of options, accessories, versions and their description for control stations»).

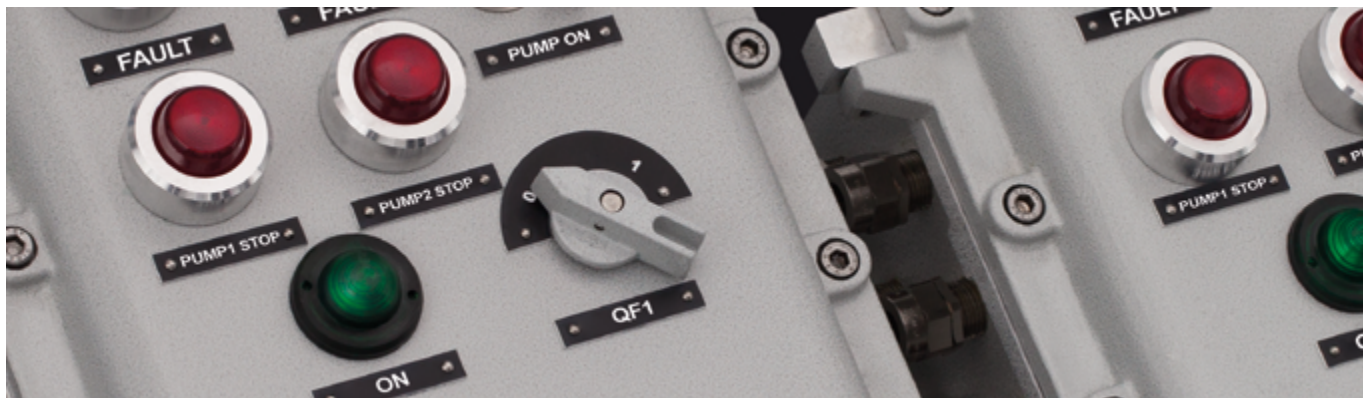

- Full production cycle from foundry to package
- Engineering and design solutions of different complexity by request
- Custom computer technology designing electrical connections and 3D models
- Ergonomic design and wide selection of control, indicating and warning elements in both standard or custom versions
- Equipment is mandatory tested to determine its resistance to electric, climatic and mechanical impacts



Cable glands available on page 124



Ex d control and indicating elements available on page 43



For the drilling data refer to page 15

FORMATION OF MARKING

Individual marking plates are applied to the control cabinets, which contain as minimum:

- product name;
- name of the manufacturer or its registered trademark;
- European conformity mark with certification body number;
- Ex-marking;
- serial number;
- ambient temperature range;
- number(s) of the certificates or a logo of the body;
- electric parameters;

and other functional data required by regulatory and technical documentation, which shall be specified in the marking by the manufacturer.

Structure of designation of SHGV... series control cabinets:

SHGVX2X3 - X4, where

- └ «SHGV» - product name;
- └ «X2» - operational environment: A - is acceptable for use in acetylene environment; no mark - is not acceptable for use in acetylene environment;
- └ «X3» - code of size of product's enclosure;
- └ «X4» - code of window size (for products with window, if any).

Structure of designation may contain a shortened functional purpose of the control cabinet in accordance with "ZAVOD GORELTEX" Co. Ltd. classifier: PUSK, RTZ, DPU, UPP, SVET, VA, DVA, UZO, VRP, AVR, IBR, IPS.

Product name can be ciphered and named as "UVG Module" or "QFM Module". Each product which is a part of module shall have an individual nameplate with the name of the product.





SHORVA - BASED



Easy access to the contents

5 different sizes available







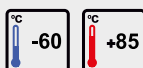
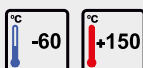
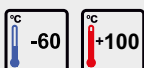

Highly resistant to the exposure of hydrogen sulfide

Highly resistant to the salt spray, hydrochloric acid vapors, salt and acidic pit water

CERTIFICATION DATA FOR EMPTY ENCLOSURES

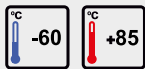
Zones for installation		
Zone 1 - Zone 2 (Gas)		Zone 21 - Zone 22 (Dust)
Version		
IECEX	Ex db IIC Gb Ex tb IIIC Db	 SHORVA empty enclosures made of aluminium-silicon alloy
ATEX	 II 2 G Ex db IIC Gb  II 2 D Ex tb IIIC Db	
Certification		
IECEX CCVE 16.0008U		All IECEX and ATEX certification data can be downloaded from www.en.exd.ru
EESF 18 ATEX 068U		
Conformance standards		
The enclosures are manufactured in accordance with the requirements of Directive 2014/34/EU ATEX standards and conform to them, IEC 60079-0: 2011, IEC 60079-1: 2014, IEC 60079-31: 2013, EN 60079-0: 2012, EN 60079-1: 2014, EN 60079-31: 2014.		
Ambient temperature. (T _{amb})	Service temperature (T _s)	Service temperature for empty enclosures with window (T _s)
		

CERTIFICATION DATA FOR JUNCTION BOXES

Zones for installation				
Zone 1 - Zone 2 (Gas)		Zone 21 - Zone 22 (Dust)		
Version				
IECEX	Ex db IIC+H ₂ T6...T4 Gb Ex db IIB T6...T4 Gb Ex tb IIIC T65°C... T120°C Db	 SHORVA. aluminum-silicon alloy junction box with lubricant on flanged joints, with terminals installed inside <i>Marking of explosion protection is formed with consideration of components installed on the surface</i>		
ATEX	 II 2 G Ex db IIC T6...T4 Gb  II 2 G Ex db IIB T6...T4 Gb  II 2 D Ex tb IIIC T65°C... T120°C Db			
Certification				
IECEX CCVE 18.0008X		All IECEX and ATEX certification data can be downloaded from www.en.exd.ru		
EESF 18 ATEX 069X				
Conformance standards				
Junction boxes are manufactured in accordance with the requirements of Directive 2014/34/EU ATEX standards and conform to them, IEC 60079-0: 2011, IEC 60079-1: 2014, IEC 60079-31: 2013, EN 60079-0: 2012, EN 60079-1: 2014, EN 60079-31: 2014.				
Permissible Ambient temperature range	Maximum voltage, V	Maximum current, A	Alternating current frequency, Hz	Range of terminated wire cross-section, mm ²
				













CERTIFICATION DATA FOR LOCAL CONTROL STATIONS

Zones for installation

Zone 1 - Zone 2 (Gas)

Zone 21 - Zone 22 (Dust)

Version

IECEX	Ex db IIB T6...T4 Gb Ex db IIC T6...T4 Gb Ex db eb mb IIB T6...T4 Gb Ex db eb mb IIC T6...T4 Gb Ex tb IIIC T51°C... T120°C Db		control stations PKIVA... on the base of SHORVA... enclosures without window
ATEX	 II 2 G Ex db IIB T6...T4 Gb  II 2 G Ex db IIC T6...T4 Gb  II 2 G Ex db eb mb IIB T6...T4 Gb  II 2 G Ex db eb mb IIC T6...T4 Gb  II 2 D Ex tb IIIC T51°C... T120°C Db		
IECEX	Ex db IIB T6...T5 Gb Ex db IIC T6...T5 Gb Ex db eb mb IIB T6...T5 Gb Ex db eb mb IIC T6...T5 Gb Ex tb IIIC T51°C... T100°C Db		control stations PKIVA... on the base of SHORVA... enclosures with window
ATEX	 II 2 G Ex db IIB T6...T5 Gb  II 2 G Ex db IIC T6...T5 Gb  II 2 G Ex db eb mb IIB T6...T5 Gb  II 2 G Ex db eb mb IIC T6...T5 Gb  II 2 D Ex tb IIIC T51°C... T100°C Db		

Certification

IECEX CCVE 18.0009X

All **IECEX** and **ATEX** certification data can be downloaded from www.en.exd.ru

EESF 19 ATEX 029X

Conformance standards

Control stations are manufactured in accordance with the requirements of Directive 2014/34/EU ATEX standards and conform to them, IEC 60079-0: 2011, IEC 60079-1: 2014, IEC 60079-7:2015, IEC 60079-18:2014, IEC 60079-31: 2013, EN 60079-0: 2012, EN 60079-1: 2014, EN 60079-7:2015, EN 60079-18:2014, EN 60079-31: 2014.

Ambient temperature (T_{amb})

- for control stations PKIVA... on the base of SHORVA... enclosures without window:

- for control stations PKIVA... on the base of SHORVA... enclosures with window:

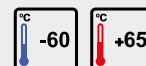
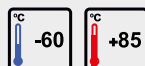

Alternating current frequency, Hz

50/60

Push button control stations, indication and signaling units can be applied in intrinsically safe circuits for circuit switching.

CERTIFICATION DATA FOR CONTROL BOARDS AND CABINETS

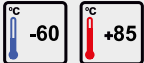
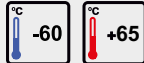
Zones for installation	
Zone 1 - Zone 2 (Gas)	Zone 21 - Zone 22 (Dust)
Version	
IECEX	Ex db IIB T6...T4 Gb Ex db eb mb IIB T6...T4 Gb Ex db IIC T6...T4 Gb Ex db eb mb IIC T6...T4 Gb Ex db [ia Ga] IIB T6...T4 Gb Ex db eb mb [ia Ga] IIB T6...T4 Gb Ex db [ia Ga] IIC T6...T4 Gb Ex db eb mb [ia Ga] IIC T6...T4 Gb Ex tb IIIC T51°C... T130°C Db
ATEX	II 2 G Ex db IIB T6...T4 Gb II 2 G Ex db eb mb IIB T6...T4 Gb II 2 G Ex db IIC T6...T4 Gb II 2 G Ex db eb mb IIC T6...T4 Gb II 2 G Ex db [ia Ga] IIB T6...T4 Gb II 2 G Ex db [ia Ga] IIB T6...T4 Gb II 2 G Ex db [ia Ga] IIC T6...T4 Gb II 2 G Ex db eb mb [ia Ga] IIC T6...T4 Gb II 2 D Ex tb IIIC T51°C... T130°C Db
IECEX	Ex db IIB T6...T5 Gb Ex db eb mb IIB T6...T5 Gb Ex db IIC T6...T5 Gb Ex db eb mb IIC T6...T5 Gb Ex db [ia Ga] IIB T6...T5 Gb Ex db eb mb [ia Ga] IIB T6...T5 Gb Ex db [ia Ga] IIC T6...T5 Gb Ex db eb mb [ia Ga] IIC T6...T5 Gb Ex tb IIIC T51°C... T100°C Db
ATEX	II 2 G Ex db IIB T6...T5 Gb II 2 G Ex db eb mb IIB T6...T5 Gb II 2 G Ex db IIC T6...T5 Gb II 2 G Ex db eb mb IIC T6...T5 Gb II 2 G Ex db [ia Ga] IIB T6...T5 Gb II 2 G Ex db [ia Ga] IIB T6...T5 Gb II 2 G Ex db [ia Ga] IIC T6...T5 Gb II 2 G Ex db eb mb [ia Ga] IIC T6...T5 Gb II 2 D Ex tb IIIC T51°C... T100°C Db
Certification	
IECEX CCVE 19.0007X	All IECEX and ATEX certification data can be downloaded from www.en.exd.ru
EESF 19 ATEX 073X	
Conformance standards	
Control cabinet are manufactured in accordance with the requirements of standards and conform to them, IEC 60079-0:2011, IEC 60079-1:2014, IEC 60079-7:2015, IEC 60079-11: 2011, IEC 60079-18:2014, IEC 60079-31:2013, EN 60079-0:2011, EN 60079-1:2014, EN 60079-7:2015, EN 60079-11: 2011, EN 60079-18:2014, EN 60079-31:2013.	
Permissible Ambient temperature range	
SHGVA...without window	SHGVA...with window
	

Maximum voltage, V		Maximum current	Alternating current frequency, Hz
1500 AC	500 DC	630 A	50/60

Marking of explosion protection is formed with consideration of components installed.

TYPE AND MAXIMUM QUANTITY OF HOLES IN ENCLOSURE AND COVER OF SHORVA

Dimension type of thread	Type of thread	SHORVA121211	SHORVA151512/ SHORVA151512-009	SHORVA171712/ SHORVA171712-009	SHORVA232316/ SHORVA232316-014	SHORVA272721/ SHORVA272721-018
02	M/NPT	3/3	5/5	6(5)/6(5)	8/8	14/14
01	M/NPT	3/3	5/5	6(5)/6(5)	8/8	14/14
1	M/NPT	2/2	4/4	5/5	8/8	14/14
2	M/NPT	2/2	3/3	3/3	8/7	11(10)/11(10)
3	M/NPT	1/1	2/2	2/2	4/4	8/8
4	M/NPT	1/1	2/2	2/2	3/3	6/6
5	M/NPT	1/1	1/1	2/2	2/2	4/4
6	M/NPT	-	-/1	1/1	2/2	3/3
7	M/NPT	-	-	-	2(1)/2	2/2
8	M/NPT	-	-	-	-	1/1
9	M/NPT	-	-	-	-	1/1
10	M/NPT	-	-	-	-	1/1



- Easy access to the contents
- 5 different sizes available
- Highly resistant to the exposure of hydrogen sulfide
- Highly resistant to the salt spray, hydrochloric acid vapors, salt and acidic pit water

MATERIALS

- The enclosure and cover are made of aluminium-silicon alloy according with magnesium content of at most 1%. The fixing bolts of the cover as well as internal and external earthing bolts are produced of stainless steel.
- The coating for the enclosures made of aluminium-silicon alloy: powder paint.
- Tempered glass of standard sizes can be used in the products.

TABLE OF DIMENSIONS

Box type	Dimensions, mm													
	Outer			Inner							Fastening			Window
	A	B	C	a	b	c	Ød	Ød1	s	v	E	F	ØG	ØL
SHORVA121211	120	120	115	93,5	93,5	74	79	M95x2	13	-	100	145	10	-
SHORVA151512	151	151	125	124	124	84	115	M130x2	13	-	126	174	11	-
SHORVA151512-009	151	151	125	124	124	76	93	M130x2	13	12	126	174	11	90
SHORVA171712	175	175	129,5	146	146	89	134,5	M150x2	14	-	150	195	11	-
SHORVA171712-009	175	175	129,5	146	146	101	137	M150x2	14	12	150	195	11	90
SHORVA232316	235	235	164	203	203	117	178	M200x2	14	-	196	267	14	-
SHORVA232316-014	235	235	164	203	203	100	161	M200x3	14	12	196	267	14	140
SHORVA272721	276,5	276,5	218	248	248	169	225	M250x3	14	-	236	316	14	-
SHORVA272721-018	276,5	276,5	218	248	248	146,5	203	M250x3	14	12	236	316	14	180

FORMATION OF MARKING

Empty enclosures type SHORVA...:

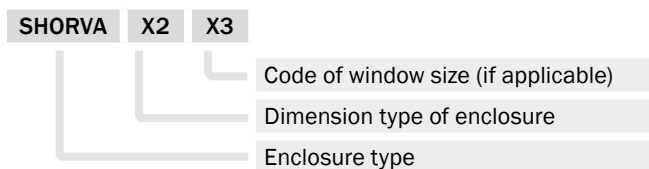

Codes of window sizes:

Enclosure type	Code of window size
	009
SHORVA...	014
	018

Code of window size characterizes position of window relative to the long side of product's enclosure (for rectangular windows).

DESIGN PARAMETERS

SHORVA boxes

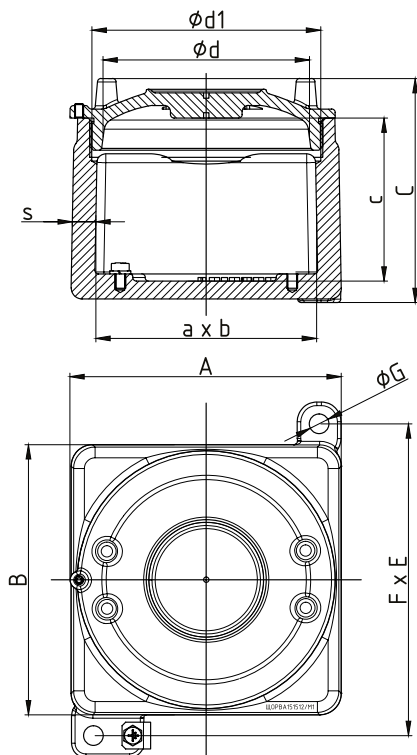

SHORVA-O boxes

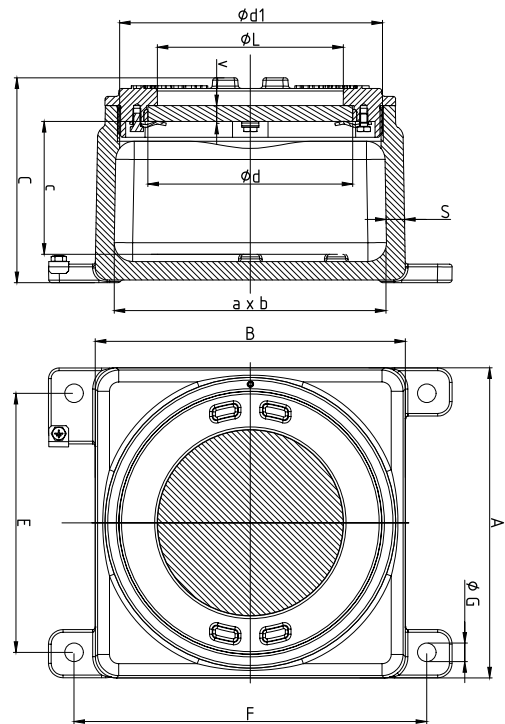

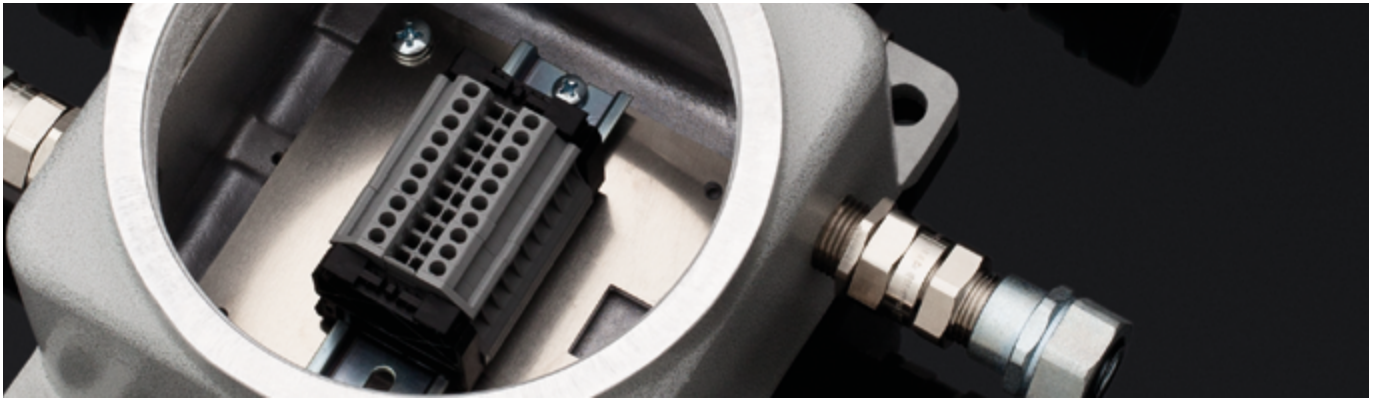

- Threaded joint of cover and enclosure ensures protection in explosive gas mixtures of IIC category
- 10 dimension types, including window version enclosures
- Enclosures are tested in conditions up to -60°C
- Lifespan of the flameproof joint is over 25 years
- Aluminum alloy provides high resistance to the exposure of hydrogen sulfide
- Uncolored internal surface increases thermal conductivity

MAXIMUM CURRENT OF INSTALLED TERMINAL CLAMPS

Type of enclosure	Rated wire cross-section, mm ²										
	1	1,5	2,5	4	6	10	16	25, 35	50	70	95
Rated current, A	10,1	13,1	18	24	30,7	42,7	57	93,7	127,5	167	204,1
Max. rated current, A <i>When up to 25% of terminals indicated in the table are installed</i>	13,5	17,5	24	32	41	57	76	125	150	192	232



Cable glands available on page 124



For the drilling data refer to page 30

FORMATION OF MARKING

Individual marking plates are applied to the junction boxes, which contain as minimum:

- product type;
- name of the manufacturer or its registered trademark;
- European conformity mark with certification body number;
- Ex-marking;
- serial number;
- ambient temperature range;
- number(s) of the certificates;
- electric parameters;

and other functional data required by regulatory and technical documentation, which shall be specified in the marking by the manufacturer.

Structure of designation of SHORVA junction boxes:

SHORVAX2 – OX3(X4X5-X4X5) – X6X7(X8) – X6X7(X8)/X9, where

- └ «SHORVA» – product name;
- └ «X2» – code of size of product's enclosure;
- └ «X3» – code of window size (for products with window)
- └ «X4» – number of terminal clamps (if any);
- └ «X5» – type of terminal clamp (if any);
- └ «X6» – number of cable glands (if any);
- └ «X7» – type of cable gland (if any);
- └ «X8» – side of cable gland location (if any);
- └ «X9» – options, accessories and versions (refer to table «Designation of options, accessories, version and its description».



- Flexible system of modulation based on one-, two-, three- or multi-button enclosures
- Ultra-high mechanical and corrosion resistance of explosion-proof pins in control elements

- Easily replaceable contact modules and light sources
- Highly resistant to hydrogen sulfide exposure
- Lifespan of the flameproof joint is over 25 years

MAXIMUM NUMBER OF INSTALLED TERMINAL CLAMPS

Product name	Maximum voltage, V	Maximum operating current, A
PKIVA... on the base of SHORVA... enclosures	1000 AC 400 DC	232

FORMATION OF MARKING

Individual marking plates are applied to the control stations, which contain as minimum:

- product name;
- name of the manufacturer or its registered trademark;
- European conformity mark with certification body number;
- Ex-marking;
- serial number;
- ambient temperature range;
- number(s) of the certificates or a logo of the body;
- electric parameters;

and other functional data required by regulatory and technical documentation, which shall be specified in the marking by the manufacturer.

Structure of designation of PKIVA... control stations:

PKIVAX2 - X3 - X4X5 - X4X5 - ... - X6X7 - X6X7 - ... / X8,
where

- └ «PKIVA» - product name;
- └ «X2» - code of size of product's enclosure;
- └ «X3» - code of window size (for products with window);
- └ «X4» - number of control element (if any);
- └ «X5» - type of control element (if any);
- └ «X6» - number of cable glands (if any);
- └ «X7» - type of cable gland (if any);
- └ «X8» - options, accessories and versions.



Cable glands available on page 124



Ex d control and indicating elements available on page 43



For the drilling data refer to page 30



- Full production cycle from foundry to package
- Engineering and design solutions of different complexity by request
- Custom computer technology designing electrical connections and 3D models
- Ergonomic design and wide selection of control, indicating and warning elements in both standard or custom versions
- Equipment is mandatory tested to determine its resistance to electric, climatic and mechanical impacts



Cable glands available on page 124



Ex d control and indicating elements available on page 43



For the drilling data refer to page 30

FORMATION OF MARKING

Individual marking plates are applied to the control cabinets, which contain as minimum:

- product name;
- name of the manufacturer or its registered trademark;
- European conformity mark with certification body number;
- Ex-marking;
- serial number;
- ambient temperature range;
- number(s) of the certificates or a logo of the body;
- electric parameters;

and other functional data required by regulatory and technical documentation, which shall be specified in the marking by the manufacturer.

Structure of designation of SHGVA series control cabinets:

SHGVAX2X3 – X4, where

- └ «SHGVA» – product name;
- └ «X2» – operational environment: A – is acceptable for use in acetylene environment; no mark – is not acceptable for use in acetylene environment;
- └ «X3» – code of size of product's enclosure;
- └ «X4» – code of window size (for products with window, if any).

Structure of designation may contain a shortened functional purpose of the control cabinet in accordance with "ZAVOD GORELTEX" Co. Ltd. classifier: PUSK, RTZ, DPU, UPP, SVET, VA, DVA, UZO, VRP, AVR, IBR, IPS.

Product name can be ciphered and named as "UVG Module" or "QFM Module". Each product which is a part of module shall have an individual nameplate with the name of the product.



KKVA - BASED

Highly resistant to the sea water

Increased heat dissipation

No microfractures

Compact size

CERTIFICATION DATA FOR EMPTY ENCLOSURES

Zones for installation

Zone 1 - Zone 2 (Gas)

Zone 21 - Zone 22 (Dust)

Version

IECEX	Ex db IIC Gb Ex tb IIIC Db		KKVA empty enclosures made of aluminium-silicon alloy
ATEX	⊕ II 2 G Ex db IIC Gb ⊕ II 2 D Ex tb IIIC Db		

Certification

IECEX CCVE 16.0008U

EESF 18 ATEX 068U

All IEC Ex and ATEX certification data can be downloaded from www.en.exd.ru

Conformance standards

The enclosures are manufactured in accordance with the requirements of Directive 2014/34/EU ATEX standards and conform to them, IEC 60079-0: 2011, IEC 60079-1: 2014, IEC 60079-31: 2013, EN 60079-0: 2012, EN 60079-1: 2014, EN 60079-31: 2014.

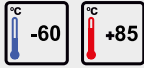
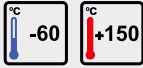
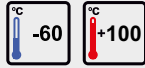
Ambient temperature (T _{amb})	Service temperature (T _s)	Service temperature for empty enclosures with window (T _s)
		

CERTIFICATION DATA FOR JUNCTION BOXES

Zones for installation

Zone 1 - Zone 2 (Gas)

Zone 21 - Zone 22 (Dust)

Version

IECEX	Ex db IIC T6...T4 Gb Ex db IIB T6...T4 Gb Ex tb IIIC T65°C... T120°C Db		KKVA.. aluminum-silicon alloy junction box with lubricant on flanged joints, with terminals installed inside
ATEX	⊕ II 2 G Ex db IIC T6...T4 Gb ⊕ II 2 G Ex db IIB T6...T4 Gb ⊕ II 2 D Ex tb IIIC T65°C... T120°C Db		

Marking of explosion protection is formed with consideration of components installed on the surface

Certification

IECEX CCVE 18.0008X

EESF 18 ATEX 069X

All IEC Ex and ATEX certification data can be downloaded from www.en.exd.ru

Conformance standards

Junction boxes are manufactured in accordance with the requirements of Directive 2014/34/EU ATEX standards and conform to them, IEC 60079-0: 2011, IEC 60079-1: 2014, IEC 60079-31: 2013, EN 60079-0: 2012, EN 60079-1: 2014, EN 60079-31: 2014.

Permissible Ambient temperature range	Maximum voltage, V	Maximum current	Alternating current frequency, Hz
			

Range of terminated wire cross-section *, mm²

1...50

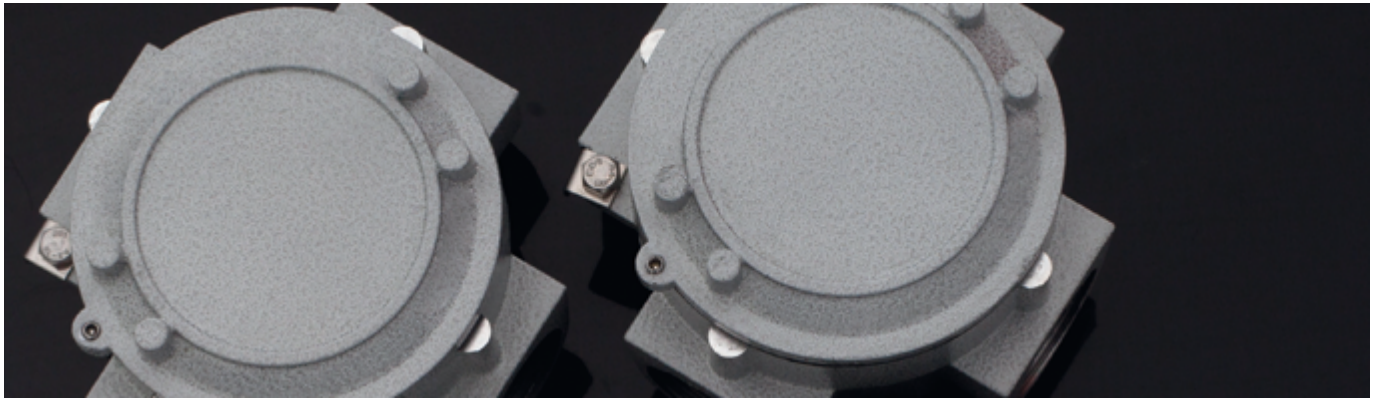

- Up to four holes in the enclosure
- Installation on the walls and ceiling at right angles allowed
- Highly resistant to the sea water
- Can be used instead of stainless steel enclosures
- No microfractures
- Increased heat dissipation
- Compact size

DIMENSIONS AND DESIGN PARAMETERS OF KKVA BOXES

Type	Number of entries, pcs/ diameter F, mm	Drawing	Cover diameter, mm	H	A1	A2	B	C	X	
KKVA-K90N1	4 x 1/2"		90	75,5	106					
KKVA-K90N2	4 x 3/4"									
KKVA-K90N3	4 x 1"									
KKVA-K144N2	4 x 3/4"			144	115	170				
KKVA-K144N3	4 x 1"									
KKVA-K144N4	4 x 1 1/4"									
KKVA-K144N5	4 x 1 1/2"									
KKVA-K144N6	4 x 2"									
KKVA-KS90N1	4 x 1/2"		90	75,5	106	-	130	-	109	
KKVA-KS90N2	4 x 3/4"									
KKVA-KS90N3	4 x 1"									
KKVA-KS144N2	4 x 3/4"			144	115	170	-	190	-	170
KKVA-KS144N3	4 x 1"									
KKVA-KS144N4	4 x 1 1/4"									
KKVA-KS144N5	4 x 1 1/2"									
KKVA-KS144N6	4 x 2"									
KKVA-TSG90N1	3 x 1/2"		90	75,5	106	-	125	121	111	
KKVA-TSG90N2	3 x 3/4"									
KKVA-TSG90N3	3 x 1"									
KKVA-TSG144N2	3 x 3/4"			144	120	170	-	160	195	130
KKVA-TSG144N3	3 x 1"									
KKVA-TSG144N4	3 x 1 1/4"									
KKVA-TSG144N5	3 x 1 1/2"									
KKVA-TSG144N6	3 x 2"									
KKVA-O90N1	1 x 1/2"		90	75,5	114	122				
KKVA-O90N2	1 x 3/4"									
KKVA-O90N3	1 x 1"									

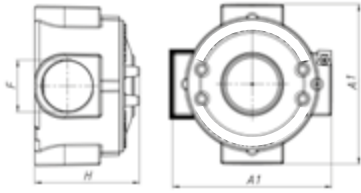
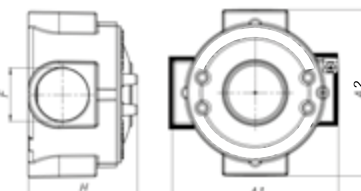
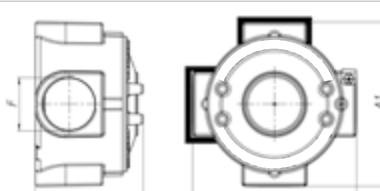
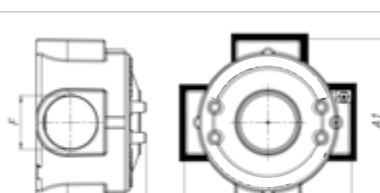
Type	Number of entries, pcs/ diameter F, mm	Drawing	Cover diameter, mm	H	A1	A2	B	C	X
KKVA-O144N2	1 x 3/4"		144	115	183	196			
KKVA-O144N3	1 x 1"								
KKVA-O144N4	1 x 1 1/4"								
KKVA-O144N5	1 x 1 1/2"								
KKVA-O144N6	1 x 2"								
KKVA-P90N1	2 x 1/2"								
KKVA-P90N2	2 x 3/4"								
KKVA-P90N3	2 x 1"								
KKVA-P144N2	2 x 3/4"		144	115	170	196			
KKVA-P144N3	2 x 1"								
KKVA-P144N4	2 x 1 1/4"								
KKVA-P144N5	2 x 1 1/2"								
KKVA-P144N6	2 x 2"								
KKVA-U90N1	2 x 1/2"								
KKVA-U90N2	2 x 3/4"								
KKVA-U90N3	2 x 1"								
KKVA-U144N2	2 x 3/4"		144	115	183	183			
KKVA-U144N3	2 x 1"								
KKVA-U144N4	2 x 1 1/4"								
KKVA-U144N5	2 x 1 1/2"								
KKVA-U144N6	2 x 2"								
KKVA-T90N1	3 x 1/2"								
KKVA-T90N2	3 x 3/4"								
KKVA-T90N3	3 x 1"								
KKVA-T144N2	3 x 3/4"		144	115	170	183			
KKVA-T144N3	3 x 1"								
KKVA-T144N4	3 x 1 1/4"								
KKVA-T144N5	3 x 1 1/2"								
KKVA-T144N6	3 x 2"								

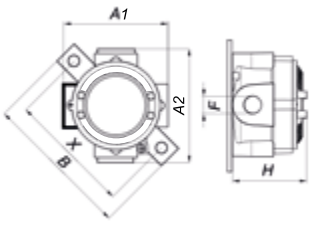
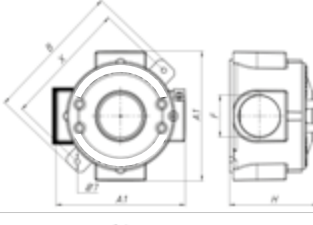
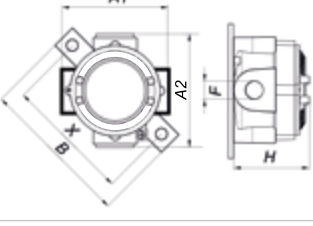
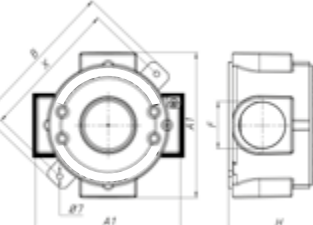
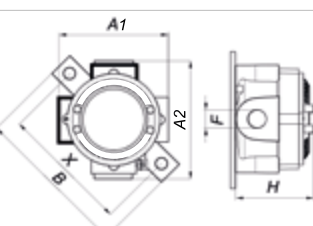
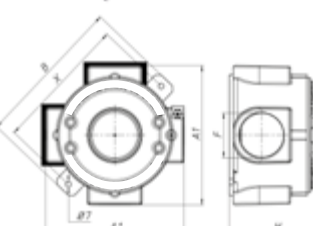
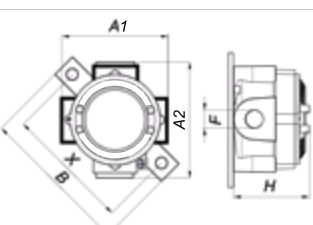
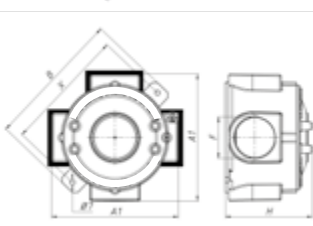
Type	Number of entries, pcs/ diameter F, mm	Drawing	Cover diameter, mm	H	A1	A2	B	C	X
KKVA-OS90N1	1 x 1/2"		90	75,5	114	122	130	-	109
KKVA-OS90N2	1 x 3/4"								
KKVA-OS90N3	1 x 1"								
KKVA-OS144N2	1 x 3/4"		144	120	183	196	190	-	170
KKVA-OS144N3	1 x 1"								
KKVA-OS144N4	1 x 1 1/4"								
KKVA-OS144N5	1 x 1 1/2"								
KKVA-OS144N6	1 x 2"								
KKVA-PS90N1	2 x 1/2"		90	75,5	106	122	130	-	109
KKVA-PS90N2	2 x 3/4"								
KKVA-PS90N3	2 x 1"								
KKVA-PS144N2	2 x 3/4"		144	120	170	196	190	-	170
KKVA-PS144N3	2 x 1"								
KKVA-PS144N4	2 x 1 1/4"								
KKVA-PS144N5	2 x 1 1/2"								
KKVA-PS144N6	2 x 2"								
KKVA-US90N1	2 x 1/2"		90	75,5	114	114	130	-	130
KKVA-US90N2	2 x 3/4"								
KKVA-US90N3	2 x 1"								
KKVA-US144N2	2 x 3/4"		144	120	183	183	190	-	170
KKVA-US144N3	2 x 1"								
KKVA-US144N4	2 x 1 1/4"								
KKVA-US144N5	2 x 1 1/2"								
KKVA-US144N6	2 x 2"								
KKVA-TS90N1	3 x 1/2"		90	75,5	106	114	130	-	109
KKVA-TS90N2	3 x 3/4"								
KKVA-TS90N3	3 x 1"								
KKVA-TS144N2	3 x 3/4"		144	120	170	183	190	-	170
KKVA-TS144N3	3 x 1"								
KKVA-TS144N4	2 x 1 1/4"								
KKVA-TS144N5	2 x 1 1/2"								
KKVA-TS144N6	2 x 2"								

FORMATION OF MARKING

Empty enclosures type KKVA...:

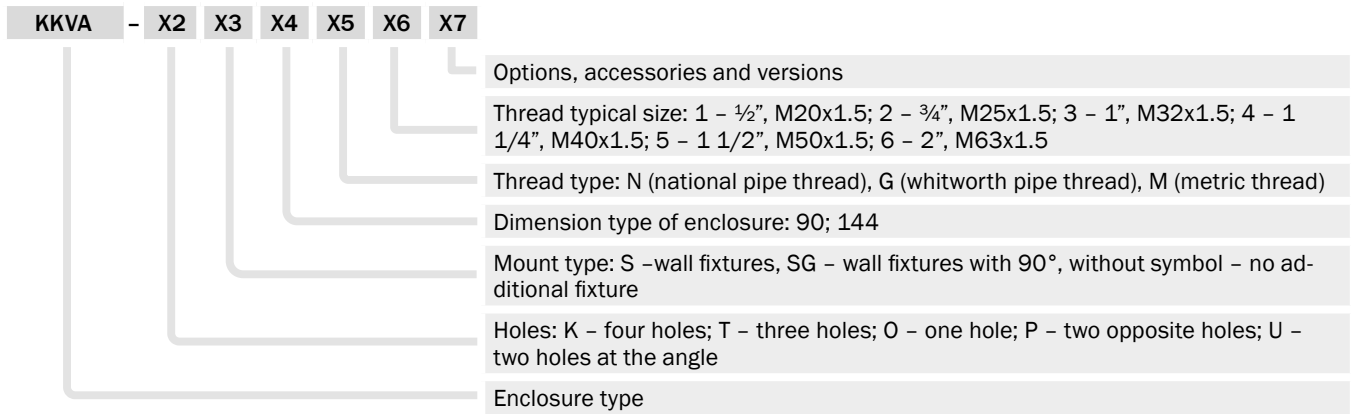

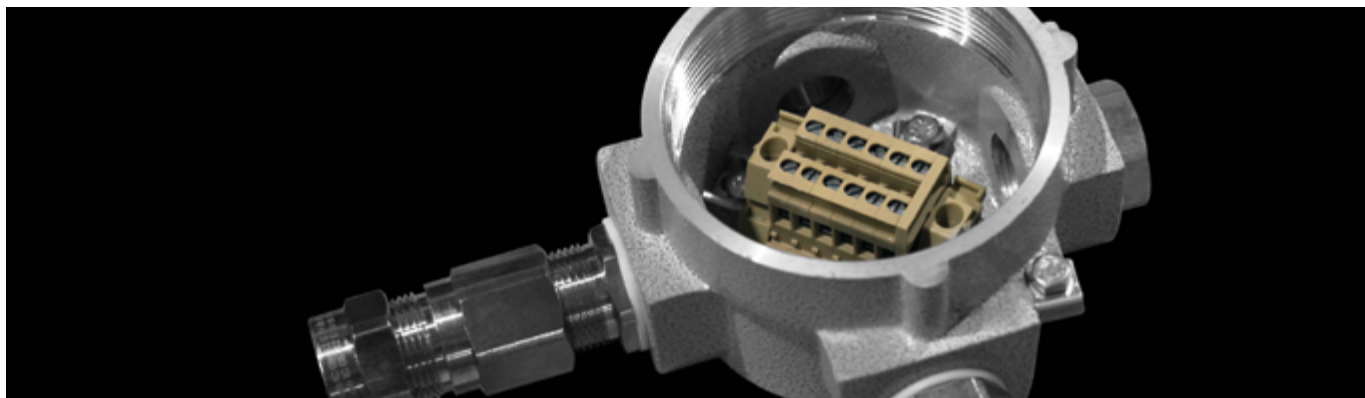

- High protection degree IP66/67
- May be equipped with terminals for wires up to 35 mm² in cross-section
- Up to four holes in the enclosure
- Various options of vertical and horizontal mounting
- KKVA-TSG boxes allow installation on the walls and ceiling at right angles
- Default thread in the holes is N (NPT) taper inch

MAXIMUM CURRENT OF INSTALLED TERMINAL CLAMPS

Type of enclosure	Rated wire cross-section, mm ²										
	1	1,5	2,5	4	6	10	16	25, 35	50	70	95
Rated current, A	10,1	13,1	18	24	30,7	42,7	57	93,7	127,5	167	204,1
Max. rated current, A <i>When up to 25% of terminals indicated in the table are installed</i>	13,5	17,5	24	32	41	57	76	125	150	192	232



Cable glands available on page 124

FORMATION OF MARKING

Individual marking plates are applied to the junction boxes, which contain as minimum:

- product type;
- name of the manufacturer or its registered trademark;
- European conformity mark with certification body number;
- Ex-marking;
- serial number;
- ambient temperature range;
- number(s) of the certificates;
- electric parameters;

and other functional data required by regulatory and technical documentation, which shall be specified in the marking by the manufacturer.

Structure of designation of KKVA junction boxes:

KKVA - X2X3X4X5X6(X7X8-X7X8) - X9(X10)/X11, where

- └ «KKVA» - product name;
- └ «X2» - number of holes;
- └ X3 - type of mounting;
- └ X4 - code of dimension type of product's enclosure;
- └ X5 - code of thread type;
- └ X6 - thread size;
- └ X7 - number of terminal clamps (if any);
- └ X8 - type of terminal clamp (if any);
- └ X9 - type of cable gland (if any);
- └ X10 - side of cable gland location (if any);
- └ X11 - options, accessories and versions (if any).



EX D CONTROL AND INDICATING ELEMENTS

High resistance to mechanical damages and corrosion







Ergonomic design

Big dimensions allow to work in gloves

Big diameter and equipped reflector



CERTIFICATION DATA FOR KGV..., LGV..., PGVA..., RGV...

Zones for installation	
Zone 1 - Zone 2 (Gas)	Zone 21 - Zone 22 (Dust)
Version	
IECEX Ex db IIC Gb Ex tb IIIC Db	 KGV..., LGV..., PGVA..., RGV...
ATEX  II 2 GD Ex db IIC Gb  II 2 D Ex tb IIIC Db	
Certification	
IECEX CCVE 17.0005U	All IEC Ex and ATEX certification data can be downloaded from www.en.exd.ru
VTT 18 ATEX 022U	
Conformance standards	
Control elements are manufactured in accordance with the requirements of IEC 60079-0:2011, IEC 60079-1:2014 and IEC 60079-31:2013 and conform to them.	
Ambient temperature (T _{amb})	Operating temperature:
 	 

CERTIFICATION DATA FOR PSGV...

Zones for installation	
Zone 1 - Zone 2 (Gas)	Zone 21 - Zone 22 (Dust)
Version	
IECEX Ex db eb mb IIC Gb Ex tb IIIC Db	 PSGV...
ATEX  II 2 G Ex db eb mb IIC Gb  II 2 D Ex tb IIIC Db	
Certification	
IECEX CCVE 18.0015U	All IEC Ex and ATEX certification data can be downloaded from www.en.exd.ru
EESF 19 ATEX 026U	
Conformance standards	
Control, indication and audible announcement elements are manufactured in accordance with the regulations of IEC 60079-0:2011, IEC 60079-1:2014, IEC 60079-7:2015, IEC 60079-18:2014, IEC 60079-31:2013, EN 60079-0:2012, EN 60079-1:2014, EN 60079-7:2015, EN 60079-18:2014, EN 60079-31:2013 standards and conform to them.	
Service temperature	
 	

- Use of corrosion-resistant aluminum, stainless steel and polyvinyl chloride ensures high resistance to mechanical damages and corrosion
- Ergonomic design of control elements, indication, control and signaling elements
- Big dimensions enable to work in gloves, which is important when working outside at low temperatures
- Big diameter and equipped reflector allows seeing the signal at wide viewing angle and upon various surface contamination
- Variety of control elements, indication, control and signaling elements in standard version and many modifications are possible upon the customer's request
- Nameplates for buttons and signal lamps manufactured upon customer's request

TECHNICAL CHARACTERISTICS OF KGV01 MOMENTARY BUTTON

Type of button	Colors	Contacts	Maximum voltage, V	Rated operational current, A	Connecting thread	Enclosure material
KGV01Z11	GREEN	1NO+1NC *	400AC 400DC	4 (at 400V) 6 (at 230V) 8 (at 120V)	M32x1,5	aluminum
KGV01ZH11	YELLOW					
KGV01K11	RED					
KGV01CH11	BLACK					
KGV01B11	WHITE					
KGV01S11	BLUE					
KGV01Z20	GREEN	2 NO *	400AC 400DC	4 (at 400V) 6 (at 230V) 8 (at 120V)	M32x1,5	aluminum
KGV01ZH20	YELLOW					
KGV01K20	RED					
KGV01CH20	BLACK					
KGV01B20	WHITE					
KGV01S20	BLUE					
KGV01Z02	GREEN	2 NC *	400AC 400DC	4 (at 400V) 6 (at 230V) 8 (at 120V)	M32x1,5	aluminum
KGV01ZH02	YELLOW					
KGV01K02	RED					
KGV01CH02	BLACK					
KGV01B02	WHITE					
KGV01S02	BLUE					
KGV01NZ11	GREEN	1NO+1NC *	400AC 400DC	4 (at 400V) 6 (at 230V) 8 (at 120V)	M32x1,5	stainless steel
KGV01NZH11	YELLOW					
KGV01NK11	RED					
KGV01NCH11	BLACK					
KGV01NB11	WHITE					
KGV01NS11	BLUE					
KGV01NZ20	GREEN	2 NO *	400AC 400DC	4 (at 400V) 6 (at 230V) 8 (at 120V)	M32x1,5	stainless steel
KGV01NZH20	YELLOW					
KGV01NK20	RED					
KGV01NCH20	BLACK					
KGV01NB20	WHITE					
KGV01NS20	BLUE					
KGV01NZ02	GREEN	2 NC *	400AC 400DC	4 (at 400V) 6 (at 230V) 8 (at 120V)	M32x1,5	stainless steel
KGV01NZH02	YELLOW					
KGV01NK02	RED					
KGV01NCH02	BLACK					
KGV01NB02	WHITE					
KGV01NS02	BLUE					

*Please note that it is possible to connect up to 6 contact modules (3 modules in 2 levels) in various combinations to button plunger.

TECHNICAL CHARACTERISTICS OF KGV12 MOMENTARY BUTTON

Type of button	Colors	Contacts	Maximum voltage, V	Rated operational current, A	Connecting thread	Enclosure material
KGV12	No color	One changeover	220AC	Non-inductive load 3 (at 12V) 3 (at 30V) 0.5 (at 125V AC) 0.25 (at 220V AC) Inductive load 1.5 (at 12V DC) 1.5 (at 30V DC) 0.05 (at 125V AC) 0.03 (at 220V AC)	M16x1.5	aluminum
KGV12N						stainless steel

*Please note that it is possible to connect up to 6 contact modules (3 modules in 2 levels) in various combinations to button plunger.

TECHNICAL CHARACTERISTICS OF KGV06 BUTTON WITH INDICATION

Type of button	Colors	Contacts	Maximum voltage, V	Rated operational current, A	Lamp cap	Connecting thread	Enclosure material
KGV06Z11	GREEN	two modules of button's contact block: 1NO+1NC module for BA9S* lamp connection	button 400AC 400DC	button 4 (at 400V) 6 (at 230V) 8 (at 120V)	BA9S** lamp	M32x1,5	aluminum
KGV06ZH11	AMBER						
KGV06K11	RED						
KGV06B11	WHITE						
KGV06S11	BLUE	BA9S* two modules of button's contact block: 2NO module for BA9S* lamp connection	button 400AC 400DC	button 4 (at 400V) 6 (at 230V) 8 (at 120V)	BA9S** lamp	M32x1,5	aluminum
KGV06Z20	GREEN						
KGV06ZH20	AMBER						
KGV06K20	RED						
KGV06B20	WHITE	BA9S* two modules of button's contact block: 2NC module for BA9S* lamp connection	button 400AC 400DC	button 4 (at 400V) 6 (at 230V) 8 (at 120V)	BA9S** lamp	M32x1,5	aluminum
KGV06S20	BLUE						
KGV06Z02	GREEN						
KGV06ZH02	AMBER						
KGV06K02	RED	two modules of button's contact block: 2NC module for BA9S* lamp connection	button 400AC 400DC	button 4 (at 400V) 6 (at 230V) 8 (at 120V)	BA9S** lamp	M32x1,5	aluminum
KGV06B02	WHITE						
KGV06S02	BLUE						
KGV06Z11	GREEN						
KGV06ZH11	AMBER						
KGV06NK11	RED						
KGV06NB11	WHITE						
KGV06S11	BLUE	BA9S* two modules of button's contact block: 2NO module for BA9S* lamp connection	button 400AC 400DC	button 4 (at 400V) 6 (at 230V) 8 (at 120V)	BA9S** lamp	M32x1,5	stainless steel
KGV06Z20	GREEN						
KGV06ZH20	AMBER						
KGV06NK20	RED						
KGV06NB20	WHITE	BA9S* two modules of button's contact block: 2NC module for BA9S* lamp connection	button 400AC 400DC	button 4 (at 400V) 6 (at 230V) 8 (at 120V)	BA9S** lamp	M32x1,5	stainless steel
KGV06S20	BLUE						
KGV06Z02	GREEN						
KGV06ZH02	AMBER						
KGV06K02	RED	two modules of button's contact block: 2NC module for BA9S* lamp connection	button 400AC 400DC	button 4 (at 400V) 6 (at 230V) 8 (at 120V)	BA9S** lamp	M32x1,5	stainless steel
KGV06B02	WHITE						
KGV06S02	BLUE						

*Only one connection module of BA9S indicating lamp may be installed.

**Indicating lamps installed into BA9S cap are for various voltage: 6DC, 6AC, 12DC, 12AC, 24DC, 24AC, 36DC, 36AC, 48DC, 48AC, 110DC, 110AC, 220AC, 380AC. Lamp voltage is indicated in the component's marking. KGV06 formation of marking.

TECHNICAL CHARACTERISTICS OF KGV07, KGV09, KGV11 EMERGENCY BUTTONS

Type of button	Colors	Contacts	Maximum voltage, V	Rated operational current, A	Connecting thread	Enclosure material
KGV07K11	RED	two modules 1NO+1NC	400AC 400DC	4 (at 400V) 6 (at 230V) 8 (at 120V)	M32x1,5	aluminum
KGV07K20	RED	two modules 2NO				
KGV07K02	RED	two modules 2NC				
KGV07NK11	RED	two modules 1NO+1NC	400AC 400DC	4 (at 400V) 6 (at 230V) 8 (at 120V)	M32x1,5	stainless steel
KGV07NK20	RED	two modules 2NO				
KGV07NK02	RED	two modules 2NC				
KGV09K11	RED	two modules 1NO+1NC	400AC 400DC	4 (at 400V) 6 (at 230V) 8 (at 120V)	M32x1,5	aluminum
KGV09K20	RED	two modules 2NO				
KGV09K02	RED	two modules 2NC				
KGV11K11	RED	two modules 1NO+1NC	400AC 400DC	4 (at 400V) 6 (at 230V) 8 (at 120V)	M32x1,5	aluminum
KGV11K20	RED	two modules 2NO				
KGV11K02	RED	two modules 2NC				
KGV11CH11	BLACK	two modules 1NO+1NC	400AC 400DC	4 (at 400V) 6 (at 230V) 8 (at 120V)	M32x1,5	aluminum
KGV11CH20	BLACK	two modules 2NO				
KGV11CH02	BLACK	two modules 2NC				
KGV11NK11	RED	two modules 1NO+1NC	400AC 400DC	4 (at 400V) 6 (at 230V) 8 (at 120V)	M32x1,5	stainless steel
KGV11NK20	RED	two modules 2NO				
KGV11NK02	RED	two modules 2NC				
KGV11NCH11	BLACK	two modules 1NO+1NC	400AC 400DC	4 (at 400V) 6 (at 230V) 8 (at 120V)	M32x1,5	stainless steel
KGV11NCH20	BLACK	two modules 2NO				
KGV11NCH02	BLACK	two modules 2NC				

TECHNICAL CHARACTERISTICS OF LGV01 LAMP

Lamp type	Colors	Connecting thread	Lamp cap	Enclosure material
LGV01Z...	GREEN	M32x1,5	BA9S*	polycarbonate
LGV01ZH...	AMBER			
LGV01K...	RED			
LGV01B...	WHITE			
LGV01S...	BLUE			
LGV01Z/C...	GREEN		built-in LED	
LGV01ZH/C...	AMBER			
LGV01K/C...	RED			
LGV01B/C...	WHITE			
LGV01S/C...	BLUE			

*Indicating lamps installed into BA9S cap are for various voltage: 6DC, 6AC, 12DC, 12AC, 24DC, 24AC, 36DC, 36AC, 48DC, 48AC, 110DC, 110AC, 220AC, 380AC.

TECHNICAL CHARACTERISTICS OF LGV03 LAMP

Lamp type	Colors	Voltage, V	Connecting thread	Lamp cap	Enclosure material
LGV03KZ*	RED + GREEN*	2.2DC	M16x1,5	Built-in LED	aluminum

*Color as agreed.

TECHNICAL CHARACTERISTICS OF PGVA, PGVAZ SWITCHES

Type	Type of switch	Closing diagram	Contacts	Maximum voltage, V	Rated operational current, A	Thread	Enclosure material
PGVA1Z	Switch		two modules 1NO+1NC	400AC	4 (at 440V) 6 (at 230V) 8 (at 120V)	M32x1.5	aluminum
PGVA2I	Switch		two modules 2NO				
PGVAZ1Z	Key operated switch		two modules 1NO+1NC				
PGVAZ2I	Key operated switch		two modules 2NO				
PGVA1ZN	Switch		two modules 1NO+1NC			stainless steel	
PGVA2IN	Switch		two modules 2NO				

TECHNICAL CHARACTERISTICS OF RGV SWITCH HANDLES

Type	Connecting thread	Material
RGV01	1/2 " G	Handle - aluminum; axle - stainless steel
RGV01N	M20x1.5	Handle - stainless steel; axle - stainless steel
RGV02	1/2 " G M20x1.5	Handle - aluminum; axle - stainless steel
RGV04	3/8 " G M16x1.5	Handle - aluminum; axle - stainless steel
RGV05	3/8 " G	Handle - aluminum; axle - stainless steel
RGV05N	M16x1.5	Handle - stainless steel; axle - stainless steel
RGV08	1/2 " G	Handle - aluminum; axle - stainless steel
RGV08N	M20x1.5	Handle - stainless steel; axle - stainless steel
RGV09	3/8 " G	Handle - aluminum; axle - stainless steel
RGV09N	M16x1.5	Handle - stainless steel; axle - stainless steel
RGV10	3/8 " G	Handle - aluminum; axle - stainless steel
RGV10N	M16x1.5	Handle - stainless steel; axle - stainless steel
RGV11	3/8 " G	Handle - aluminum; axle - stainless steel
RGV11N	M16x1.5	Handle - stainless steel; axle - stainless steel
RGV13	3/8 " G	Handle - aluminum; axle - stainless steel
RGV13N	M16x1.5	Handle - stainless steel; axle - stainless steel
RGV12	3/8 " G M16x1.5	Rheostat handle - aluminum; axle - stainless steel

STOPPERS FOR BLOCKING SWITCH HANDLES (EXCEPT FOR RGV12)

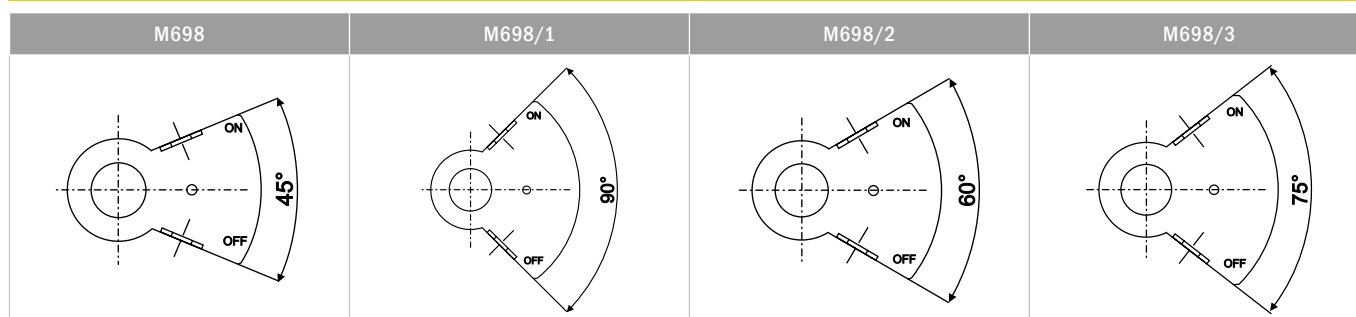

TECHNICAL CHARACTERISTICS OF PSG TYPE SIRENS

Type	Sound pressure, dB	Maximum voltage, V	Rated operational current, A	Enclosure material
PSGV01	106	12DC	0,15	Aluminum
PSGV02	108	12DC	0,15	Aluminum

CAD GORELTEX



The Goreltex CAD system allows to automatically create blueprints of explosion-proof terminal boxes, control stations, starters and cable glands. It does not require nor special skills in the engineering of explosion-proof equipment neither deep knowledge of standards and algorithms as the system main purpose is to to avoid most errors.



KSRV - BASED

Highly resistant to mechanical impact and vibration

Increased wall thickness

Extended side surface area to install more cable glands

External brackets provide easier installation



CERTIFICATION DATA FOR EMPTY ENCLOSURES

Zones for installation

Zone 1 - Zone 2 (Gas)

Zone 21 - Zone 22 (Dust)

Version

IECEX	Ex eb IIC Gb Ex ia IIC Gb Ex tb IIIC Db		KSRV... empty enclosures made from aluminum alloy, stainless steel and mild steel
ATEX	 II 2 G Ex eb IIC Gb  II 2 G Ex ia IIC Gb  II 2 D Ex tb IIIC Db		

Certification

IECEX CCVE 18.0013U

All **IECEX** and **ATEX** certification data can be downloaded from www.en.exd.ru

EESF 19 ATEX 012U

Conformance standards

The enclosures are manufactured in accordance with the requirements of Directive 2014/34/EU ATEX standards and conform to them, IEC 60079-0: 2011, IEC 60079-7: 2015, IEC 60079-11: 2011, IEC 60079-31: 2013, EN 60079-0: 2012, EN 60079-7: 2015, EN 60079-11: 2012, EN 60079-31: 2012.

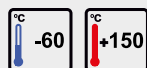
Service temperature (T_s)Service temperature for empty enclosures with window (T_s)





CERTIFICATION DATA FOR JUNCTION BOXES

Zones for installation

Zone 1 - Zone 2 (Gas)

Zone 21 - Zone 22 (Dust)

Version

IECEX	Ex eb IIC T6...T4 Gb Ex ia IIC T6...T4 Gb Ex eb ia IIC T6...T4 Gb Ex tb IIIC T85°C... T135°C Db		KSRV
ATEX	 II 2 G Ex eb IIC T6...T4 Gb  II 2 G Ex ia IIC T6...T4 Gb  II 2 G Ex eb ia IIC T6...T4 Gb  II 2 D Ex tb IIIC T85°C... T135°C Db		

Certification

IECEX CCVE 19.0004X

All **IEC Ex** and **ATEX** certification data can be downloaded from www.en.exd.ru

EESF 19 ATEX 034X

Conformance standards

Junction boxes are manufactured in accordance with the requirements of Directive 2014/34/EU ATEX standards and conform to them, IEC 60079-0: 2011, IEC 60079-7: 2006, IEC 60079-11: 2011, IEC 60079-31: 2013, EN 60079-0: 2012, EN 60079-7: 2007, EN 60079-11: 2012, EN 60079-31: 2014.

Permissible Ambient temperature range



Maximum voltage, V

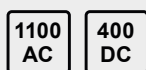

Maximum current, A

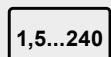

Alternating current frequency, Hz

Range of terminated wire cross-section, mm²





CERTIFICATION DATA FOR LOCAL CONTROL STATIONS

Zones for installation

Zone 1 - Zone 2 (Gas)

Zone 21 - Zone 22 (Dust)

Version

IECEX	Ex db eb IIC T4...T6 Gb Ex eb mb IIC T4...T6 Gb Ex db eb mb IIC T4...T6 Gb Ex tb IIIC T85°C... T135°C Db		PKIE... series control stations made of aluminum alloy, stain-less steel and mild steel <i>Marking of explosion protection is formed with consideration of components installed on the surface</i>
ATEX	 II 2 G Ex db eb IIC T4...T6 Gb  II 2 G Ex eb mb IIC T4...T6 Gb  II 2 G Ex db eb mb IIC T4...T6 Gb  II 2 D Ex tb IIIC T85°C... T135°C Db		

Certification

IECEX CCVE 19.0002X

All IEC Ex and ATEX certification data can be downloaded from www.en.exd.ru

EESF 19 ATEX 053X

Conformance standards

Control stations are manufactured in accordance with the requirements of Directive 2014/34/EU ATEX standards and conform to them, IEC 60079-0: 2011, IEC 60079-7: 2006, IEC 60079-11: 2011, IEC 60079-31: 2013, EN 60079-0: 2012, EN 60079-7: 2007, EN 60079-11: 2012, EN 60079-31: 2014.

Permissible Ambient temperature range	Maximum voltage, V	Maximum current, A	Alternating current frequency, Hz
 -60  +85	 1100 AC  400 DC	 291 A	 50/60

**KSRV**

- Highly resistant to mechanical impact and vibration
- Increased wall thickness
- Side surfaces area is extended to install more cable glands
- External brackets provide easier installation
- 10 dimension types
- Looped pattern sealing system ensures IP66 protection degree

KSRV-N

- Installation of removable plates for cable glands upon request
- Lock installation on the cover available upon request
- Extended drilling area for cable glands installation
- Fastening bolts are equipped with special sealant for ingress protection

KSRV-M

- Antistatic polymer epoxy coating
- Removable cover on hinges
- Whole-filled silicone sealing on the cover
- 15 standard sizes, also available manufacturing per customer specifications
- Manufacturing windows available per customer specifications
- Lock installation on the cover on request

MATERIALS

- The enclosure and cover are made of aluminum alloy with magnesium content of at most 1%, manufactured of stainless steel (KSRV-N enclosures) or mild steel (KSRV-M enclosures). The fixing bolts of the cover as well as internal and external earthing bolts are produced of stainless steel.
- The coating for the enclosures made of aluminum alloy and mild steel: powder paint. Method of application: electrostatic spray gun or tribostatic gun.
- Silicone rings shall be used for provision of IP54/IP66 ingress protection degree of enclosure.
- Tempered glass of standard sizes can be applied in enclosures.

DIMENSIONS AND DESIGN PARAMETERS

Dimension type of enclosure	Dimensions, mm											
	External			Internal					Fastening			Quantity of fastening bolts
	A	B	C	a	b	c	s1	s2	X	Y	ØD	Q
KSRV111109	112	112	91	102	102	79	5	6	94	94	6,3	4
KSRV171109	172	112	91	162	102	72	5	6	154	94	6,3	4
KSRV141410	149,5	149,5	107	139,5	139,5	88	5	6	131	131	6,3	4
KSRV202012	201	201	129	191	191	106	5	6	180	180	6,3	4
KSRV301410	304,5	149,5	109	294,5	139,5	88	5	6	285	131	6,3	4
KSRV302314	305	231	140	295	221	117	5	6	285	211	6,3	4
KSRV342421	348	243	212	312	211	180	8	8	255	250	9	4
KSRV513320	511	336	207	479	294	178	8	8	434	338	9	6
KSRV663221	669	329	207	637	287	178	8	8	576	332	9	8
KSRV626221	622	622	208	580	580	178	8	8	530	616	9	6

DIMENSIONS OF KSRV-N AND KSRV-M

Dimension type of enclosure	Dimensions, mm							Quantity of hinges	Mounting dimensions of hinges			Quantity of fastening bolts		
	External			Fastening					P	X	X1	X2	Q (without hinges)	Q (with hinges)
	A	B	C	G1	H1	G2	H2							
KSRV-N111109 / KSRV-M111109	110	110	90	80	137	137	80	2	-	-	-	4	2	
KSRV-N151512 / KSRV-M151512	150	150	120	177	120	120	177	2	110	-	-	4	2	
KSRV-N171109 / KSRV-M171109	176	116	95	203	86	86	203	2	-	-	-	4	2	
KSRV-N202012 / KSRV-M202012	200	200	120	227	170	170	227	2	160	-	-	4	2	
KSRV-N231815 / KSRV-M231815	230	180	150	257	150	150	257	2	170	-	-	4	2	
KSRV-N232315 / KSRV-M232315	230	230	150	257	200	200	257	2	170	-	-	4	2	
KSRV-N303012 / KSRV-M303012	300	300	120	327	270	270	327	2	160	-	-	6	4	
KSRV-N322312 / KSRV-M322312	320	230	120	347	200	200	347	2	180	-	-	4	4	
KSRV-N342315 / KSRV-M342315	340	230	150	367	200	200	367	2	200	-	-	4	4	
KSRV-N343415 / KSRV-M343415	340	340	150	367	310	310	367	2	200	-	-	6	4	
KSRV-N402315 / KSRV-M402315	400	230	150	427	200	200	427	2	260	-	-	4	2	
KSRV-N453415 / KSRV-M453415	450	340	150	477	310	310	477	2	310	-	-	6	4	
KSRV-N534315 / KSRV-M534315	530	430	150	557	400	400	557	2	390	-	-	8	6	
KSRV-N606025 / KSRV-M606025	600	600	250	627	570	570	627	3	460	230	-	8	5	
KSRV-N806030 / KSRV-M806030	800	600	300	827	570	570	827	3	660	330	-	8	5	
KSRV-N1008030 / KSRV-M1008030	1000	800	300	1027	770	770	1027	4	780	-	260	14	10	

DESIGN PARAMETERS OF KSRV ENCLOSURES

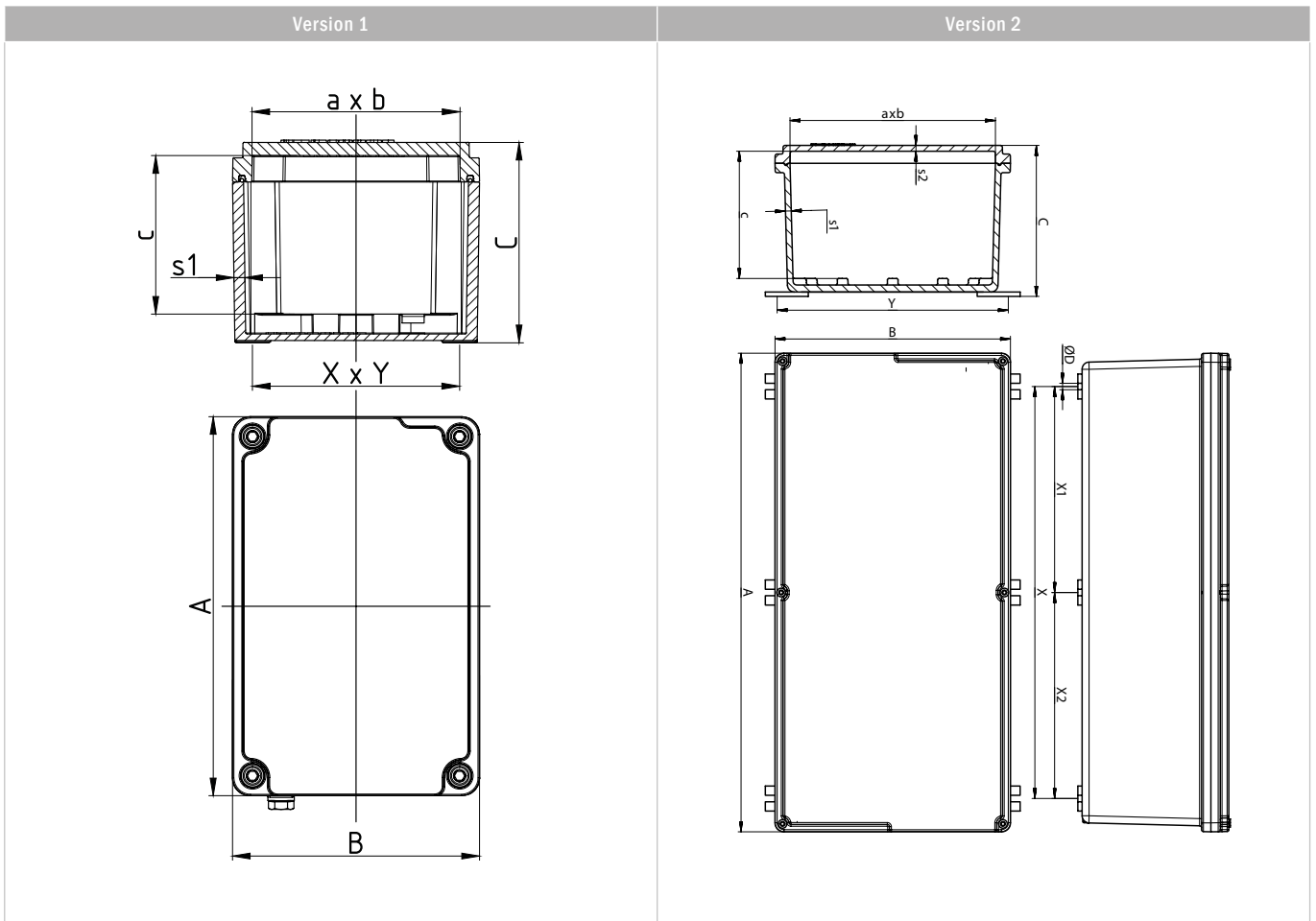

DESIGN PARAMETERS OF KSRV-N AND KSRV-M ENCLOSURES

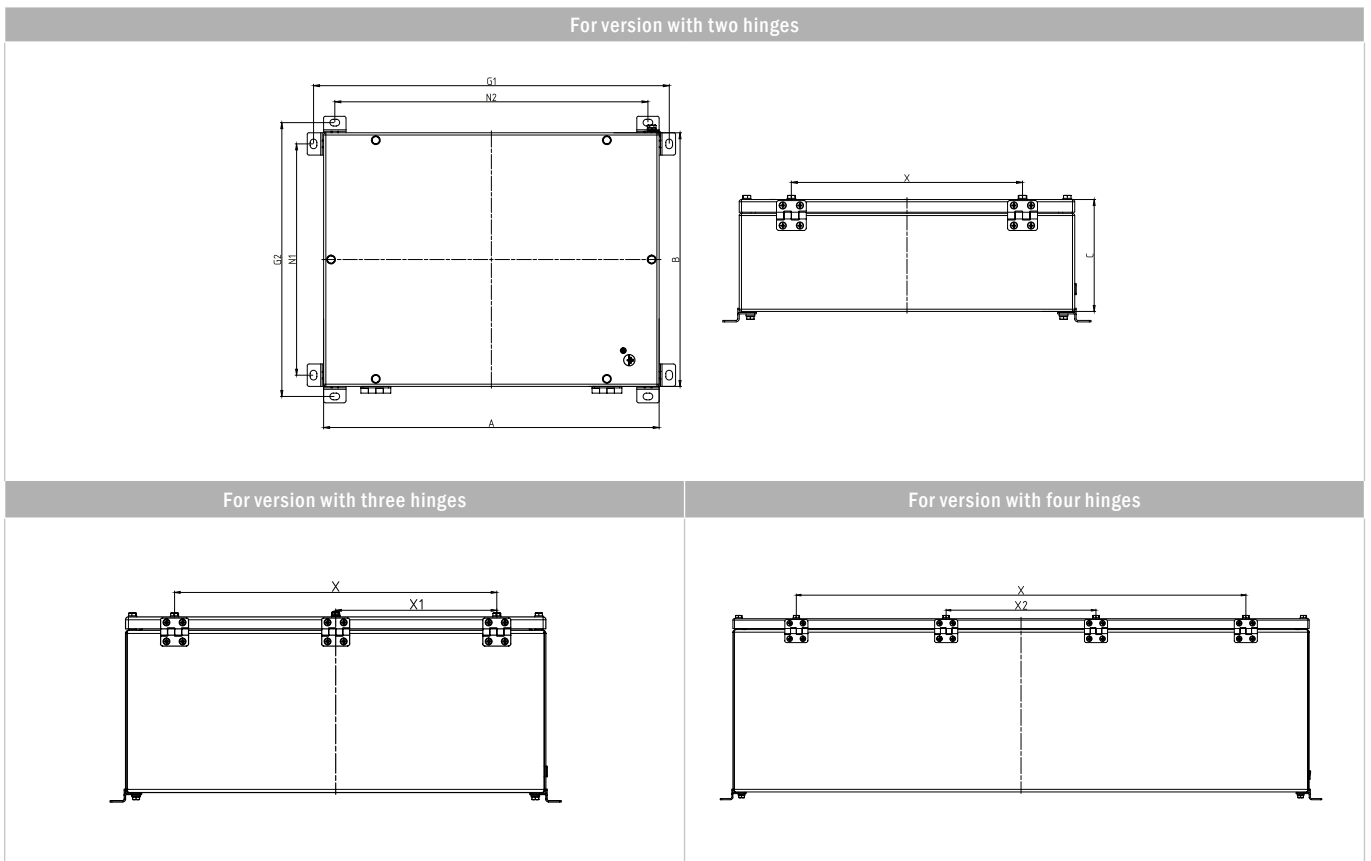

KSRV-N and KSRV-M boxes with hinges are given on figure. Version of the boxes without hinges structurally does not differ in any aspect apart from absence of the hinges and presence of additional bolts.

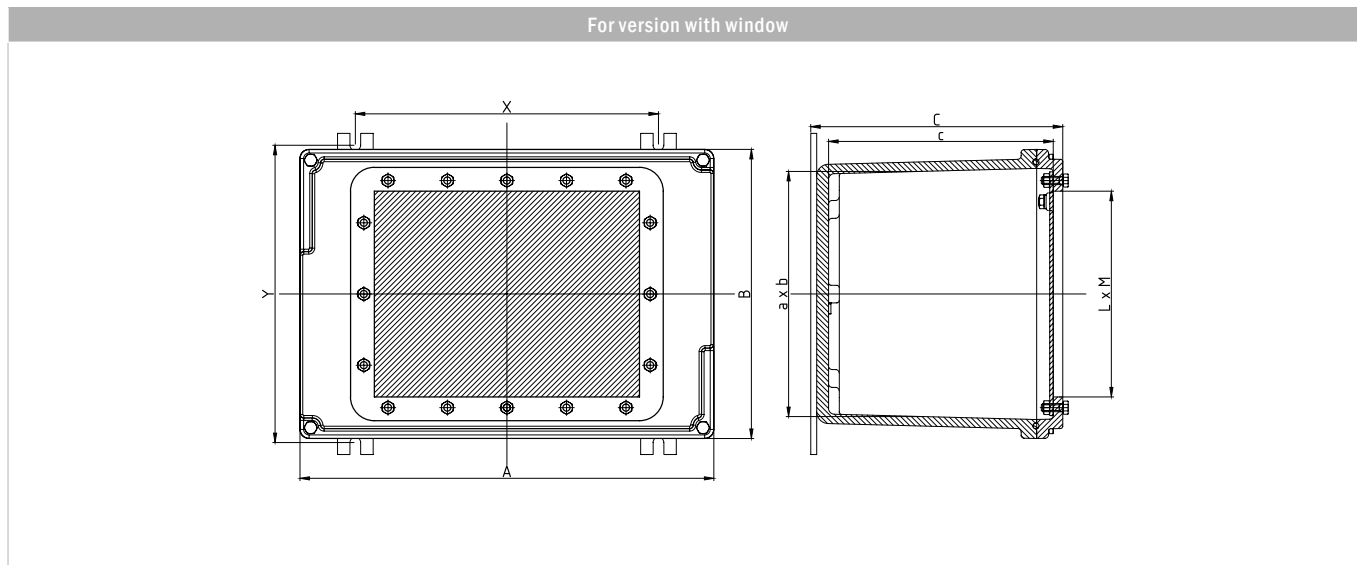

FORMATION OF MARKING

Empty enclosures type KSRV...:

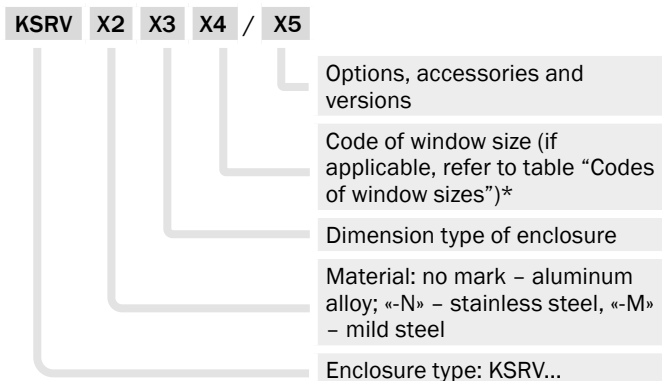

Codes of window sizes

Code of window size	Standard dimension of window (L×H)
00808	80×80
01508	150×80
01515	150×150
02515	250×150
02525	250×250
03725	370×250
03737	370×370



KSRV

- Highly resistant to mechanical impact and vibration
- Increased wall thickness
- Side surfaces area is extended to install more cable glands
- External brackets provide easier installation
- 10 dimension types
- Looped pattern sealing system ensures IP66 protection degree

KSRV-N

- Lock installation on the cover available upon request
- Extended drilling area for cable glands installation
- Fastening bolts are equipped with special sealant for ingress protection

KSRV-M

- Cost-saving solution
- Replaceable plates for cable glands

Maximum values of current fed to the terminals for each type of junction box depending on the ambient temperature and rated cross-section of the wire are given in the tables.

Maximum Ambient temperature, °C	Temperature class	Max. surface temperature	Max. service temperature of terminals*
-60...+40	T6	85	80
-60...+55	T5	100	95
-60...+70	T4	135	110
-60...+85	T4	135	130

*The maximum Service temperature of terminals installed inside the enclosures should be equal or greater than the temperature indicated into the tables shown above.

Maximum values of current fed to the terminals for each type of junction box depending on the ambient temperature and rated cross-section of the wire

Maximum currents for max. ambient temperature	Maximum current [A] for each conductor cross-section in mm ²															
	1,5	2,5	4	6	10	16	25	35	50	70	95	120	150	185	240	
before + 55 °C	12	17	22	29	40	53	75	88	105	134	162	188	216	250	291	
before + 70 °C	10	14	19	25	34	45	64	74,8	89,3	114	138	160	184	213	247	
before + 85 °C	10	14	19	25	34	45	64	-	-	-	-	-	-	-	-	

*A range of wire sections may not be applicable depending on enclosure dimension type



Cable glands available on page 124

FORMATION OF MARKING

Individual marking plates are applied to the junction boxes, which contain as minimum:

- product type;
- name of the manufacturer or its registered trademark;
- European conformity mark with certification body number;
- Ex-marking;
- serial number;
- ambient temperature range;
- number(s) of the certificates or a logo of the body;
- electric parameters;

and other functional data required by regulatory and technical documentation, which shall be specified in the marking by the manufacturer.

Structure of designation of KSRV junction boxes:

KSRVX2X3 – X4(X5X6-X5X6) – X7X8(X9) – X7X8(X9)/X10,
where

- └ «KSRV» – product name;
- └ «X2» – material: no mark – aluminum alloy; «-N» – stainless steel, «-M» – mild steel;
- └ «X3» – code of size of product's enclosure;
- └ «X4» – code of window size (for products with window);
- └ «X5» – number of terminal clamps (if any);
- └ «X6» – type of terminal clamp (if any);
- └ «X7» – number of cable glands (if any);
- └ «X8» – type of cable gland (if any);
- └ «X9» – side of cable gland location (if any);
- └ «X10» – options, accessories and versions (refer to table «Designation of options, accessories, version and its description».



- Flexible modular system comprises enclosures in different dimensions and various control and indicating elements
- Cable glands, control and indicating elements are installed according to customers' requirements
- Control and indicating modules are brightly colored

FORMATION OF MARKING

Individual marking plates are applied to the control stations, which contain as minimum:

- product type;
- name of the manufacturer or its registered trademark;
- European conformity mark with certification body number;
- Ex-marking;
- serial number;
- ambient temperature range;
- number(s) of the certificates or a logo of the body;
- electric parameters;

and other functional data required by regulatory and technical documentation, which shall be specified in the marking by the manufacturer.

Structure of designation of PKIE... control station:

PKIEX2X3 - X4 - X5X6 ... X5X6 - X7X8(X9) - X7X8(X9) / X10, where

- └ «PKIE» - product name;
- └ «X2» - material: no mark - aluminum alloy; «-N» - stainless steel, «-M» - mild steel;
- └ «X3» - code of size of product's enclosure;
- └ «X4» - code of window size (for products with window);
- └ «X5» - number of terminal clamps (if any);
- └ «X6» - type of terminal clamp (if any);
- └ «X7» - number of cable glands (if any);
- └ «X8» - type of cable gland (if any);
- └ «X9» - side of cable gland location (if any);
- └ «X10» - options, accessories and versions (refer to table «Designation of options, accessories, version and its description».



Cable glands available on page 124



Ex e control and indicating elements available on page 60



EX E CONTROL AND INDICATING ELEMENTS

High resistance to mechanical damages and corrosion

Ergonomic design

Big dimensions allow to work in gloves

Big diameter and equipped reflector



CERTIFICATION DATA FOR KGE..., PGE...

Zones for installation

Zone 1 - Zone 2 (Gas)

Zone 21 - Zone 22 (Dust)

Version

IECEX Ex db eb IIC Gb
Ex tb IIIC Db



KGE..., PGE...

ATEX II 2 G Ex db eb IIC Gb
II 2 D Ex tb IIIC Db

Certification

IECEX CCVE 18.0015U

All IEC Ex and ATEX certification data can be downloaded from
www.en.exd.ru

Conformance standards

Control, indication and audible announcement elements are manufactured in accordance with the regulations of IEC 60079-0:2011, IEC 60079-1:2014, IEC 60079-7:2015, IEC 60079-18:2014, IEC 60079-31:2013, EN 60079-0:2012, EN 60079-1:2014, EN 60079-7:2015, EN 60079-18:2014, EN 60079-31:2013 standards and conform to them.

Service temperature

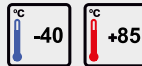

CERTIFICATION DATA FOR LGE...

Zones for installation

Zone 1 - Zone 2 (Gas)

Zone 21 - Zone 22 (Dust)

Version

IECEX Ex db eb IIC Gb
Ex tb IIIC Db



LGE...

ATEX II 2 G Ex db eb IIC Gb
II 2 D Ex tb IIIC Db

Certification

IECEX CCVE 18.0015U

All IEC Ex and ATEX certification data can be downloaded from
www.en.exd.ru

EESF 19 ATEX 026U

Conformance standards

Control, indication and audible announcement elements are manufactured in accordance with the regulations of IEC 60079-0:2011, IEC 60079-1:2014, IEC 60079-7:2015, IEC 60079-18:2014, IEC 60079-31:2013, EN 60079-0:2012, EN 60079-1:2014, EN 60079-7:2015, EN 60079-18:2014, EN 60079-31:2013 standards and conform to them.

Service temperature

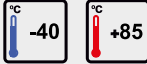

CERTIFICATION DATA FOR PTCE...

Zones for installation	
Zone 1 - Zone 2 (Gas)	Zone 21 - Zone 22 (Dust)
Version	
IECEX	Ex db eb IIC Gb Ex tb IIIC Db
ATEX	⊕ II 2 G Ex db eb IIC Gb ⊕ II 2 D Ex tb IIIC Db
	
PTCE...	
Certification	
IECEX CCVE 18.0015U	All IEC Ex and ATEX certification data can be downloaded from www.en.exd.ru
Conformance standards	
Control, indication and audible announcement elements are manufactured in accordance with the regulations of IEC 60079-0:2011, IEC 60079-1:2014, IEC 60079-7:2015, IEC 60079-18:2014, IEC 60079-31:2013, EN 60079-0:2012, EN 60079-1:2014, EN 60079-7:2015, EN 60079-18:2014, EN 60079-31:2013 standards and conform to them.	
Service temperature	
	

CERTIFICATION DATA FOR PSGE...

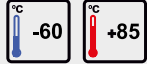
Zones for installation	
Zone 1 - Zone 2 (Gas)	Zone 21 - Zone 22 (Dust)
Version	
IECEX	Ex eb mb IIC Gb Ex tb IIIC Db
ATEX	⊕ II 2 G Ex eb mb IIC Gb ⊕ II 2 D Ex tb IIIC Db
	
PSGE...	
Certification	
IECEX CCVE 18.0015U	All IEC Ex and ATEX certification data can be downloaded from www.en.exd.ru
EESF 19 ATEX 026U	
Conformance standards	
Control, indication and audible announcement elements are manufactured in accordance with the regulations of IEC 60079-0:2011, IEC 60079-1:2014, IEC 60079-7:2015, IEC 60079-18:2014, IEC 60079-31:2013, EN 60079-0:2012, EN 60079-1:2014, EN 60079-7:2015, EN 60079-18:2014, EN 60079-31:2013 standards and conform to them.	
Service temperature	
	

- Use of corrosion-resistant aluminum, stainless steel and polyvinyl chloride ensures high resistance to mechanical damages and corrosion
- Ergonomic design of control elements, indication, control and signaling elements
- Big dimensions enable to work in gloves, which is important when working outside at low temperatures
- Big diameter and equipped reflector allows seeing the signal at wide viewing angle and upon various surface contamination
- Variety of control elements, indication, control and signaling elements in standard version and many modifications are possible upon the customer's request
- Nameplates for buttons and signal lamps manufactured upon customer's request

TECHNICAL CHARACTERISTICS OF KGE01 MOMENTARY BUTTON

Type of button	Contacts	Colors	Maximum voltage, V	Rated operational current, A			Enclosure material
				AC-12*	AC-15*	DC-13*	
KGE01K11	1NO+1NC	RED	400AC 400DC	10 (at 400V) 16 (at 250V) 16 (at 120V) 16 (at 24V) 16 (at 12V)	6 (at 400V) 10 (at 250V) 16 (at 120V)	0,5 (at 250V) 1 (at 110V) 2 (at 24V) 2 (at 12V)	plastic
KGE01K20	2NO						
KGE01K02	2NC						
KGE01Z11	1NO+1NC	GREEN					
KGE01Z20	2NO						
KGE01Z02	2NC						
KGE01ZH11	1NO+1NC	YELLOW					
KGE01ZH20	2NO						
KGE01ZH02	2NC						
KGE01S11	1NO+1NC	BLUE					
KGE01S20	2NO						
KGE01S02	2NC						
KGE01B11	1NO+1NC	WHITE					
KGE01B20	2NO						
KGE01B02	2NC						
KGE01CH11	1NO+1NC	BLACK					
KGE01CH20	2NO						
KGE01CH02	2NC						

*Application in other groups is permitted, ratings depend on the code of the category of application.

TECHNICAL CHARACTERISTICS OF KGE01 MOMENTARY BUTTON

Type of button	Contacts	Colors	Maximum voltage, V	Rated operational current, A			Enclosure material
				AC-12*	AC-15*	DC-13*	
KGE02KZ11	1NO+1NC	RED GREEN**	400AC 400DC	10 (at 400V) 16 (at 250V) 16 (at 120V) 16 (at 24V) 16 (at 12V)	6 (at 400V) 10 (at 250V) 16 (at 120V)	0,5 (at 250V) 1 (at 110V) 2 (at 24V) 2 (at 12V)	plastic
KGE02KZ20	2NO						
KGE02KZ02	2NC						

*Application in other groups is permitted, ratings depend on the code of the category of application.

** - color as agreed

TECHNICAL CHARACTERISTICS OF KGE06 LOCKABLE BUTTON WITH LOCK

Type of button	Colors	Closing diagram	Contacts	Maximum voltage, V	Rated operational current, A			Enclosure material
					AC-12*	AC-15*	DC-13*	
KGE06K10	RED		1H0	400AC 400DC	10 (at 400V)	6 (at 400B) 10 (at 250V)	0,5 (at 250V) 1 (at 110V) 2 (at 24V) 2 (at 12V)	plastic
KGE06Z10	GREEN							
KGE06ZH10	YELLOW							
KGE06S10	BLUE							
KGE06B10	WHITE							
KGE06K01	RED		1H3	400AC 400DC	10 (at 400V)	6 (at 400B) 10 (at 250V)	0,5 (at 250V) 1 (at 110V) 2 (at 24V) 2 (at 12V)	plastic
KGE06Z01	GREEN							
KGE06ZH01	YELLOW							
KGE06S01	BLUE							
KGE06B01	WHITE							

*Application in other groups is permitted, ratings depend on the code of the category of application.

Installed lamp has different voltage values: 24...48DC, 24...240AC. Lamp voltage is indicated in the component's marking.

TECHNICAL CHARACTERISTICS OF KGE07, KGE08, KGE09 LOCKING EMERGENCY STOP BUTTONS

Type of button	Contacts	Colors	Maximum voltage, V	Rated operational current, A			Enclosure material
				AC-12*	AC-15*	DC-13*	
KGE07K11	1NO+1NC	RED	400AC 400DC	10 (at 400V) 16 (at 250V) 16 (at 120V) 16 (at 24V) 16 (at 12V)	6 (at 400V) 10 (at 250V) 16 (at 120V)	0,5 (at 250V) 1 (at 110V) 2 (at 24V) 2 (at 12V)	plastic
KGE07K20	2NO						
KGE07K02	2NC						
KGE08K11	1NO+1NC	RED (with yellow rim)					
KGE08K20	2NO						
KGE08K02	2NC						
KGE09K11	1NO+1NC	RED (with yellow rim)					
KGE09K20	2NO						
KGE09K02	2NC						

*Application in other groups is permitted, ratings depend on the code of the category of application.

TECHNICAL CHARACTERISTICS OF KGE10 MOMENTARY BUTTON

Type of button	Contacts	Maximum voltage, V	Rated operational current, A			Enclosure material
			AC-12*	AC-15*	DC-13*	
KGE10K11	1NO+1NC	400AC 400DC	10 (at 400V) 16 (at 250V) 16 (at 120V) 16 (at 24V) 16 (at 12V)	6 (at 400V) 10 (at 250V) 16 (at 120V)	0,5 (at 250V) 1 (at 110V) 2 (at 24V) 2 (at 12V)	plastic
KGE10K20	2NO					
KGE10K02	2NC					
KGE10CH11	1NO+1NC					
KGE10CH20	2NO					
KGE10CH02	2NC					

*Application in other groups is permitted, ratings depend on the code of the category of application.

TECHNICAL CHARACTERISTICS OF LGE03 LAMP

Lamp type	Colors	Lamp cap	Rated voltage of indication, V	Consumed power, W	Enclosure material
LGE03K12	RED	Built-in LED	12AC/DC	1	plastic
LGE03Z12	GREEN				
LGE03ZH12	YELLOW				
LGE03S12	BLUE				
LGE03B12	WHITE				
LGE03K24	RED				
LGE03Z24	GREEN		16..36AC/DC		
LGE03ZH24	YELLOW				
LGE03S24	BLUE				
LGE03B24	WHITE				
LGE03K220	RED				
LGE03Z220	GREEN				
LGE03ZH220	YELLOW				
LGE03S220	BLUE				
LGE03B220	WHITE				

TECHNICAL CHARACTERISTICS OF PGE, PGEZ, PGEPKL SWITCHES

Type	Closing diagram	Contacts	Type of switch	Maximum voltage, V	Rated operational current, A			Enclosure material
					AC-12*	AC-15*	DC-13*	
PGE1C		2NO	Handle	400AC 400DC	10 (at 400V) 16 (at 250V) 16 (at 120V) 16 (at 24V) 16 (at 12V)	6 (at 400V) 10 (at 250V) 16 (at 120V)	0,5 (at 250V) 1 (at 110V) 2 (at 24V) 2 (at 12V)	plastic
PGE2I		2NO						
PGE1Z		1NO+1N3						
PGE1W		1NO+1N3						
PGE2C		4NO						
PGE2I		4NO						
PGE2Z		2NO+2N3						
PGEZ1C		2NO						
PGEZ2I		2NO						

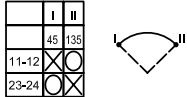
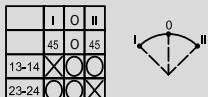
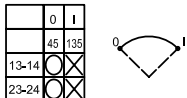
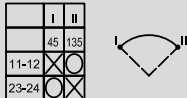
Type	Closing diagram	Contacts	Type of switch	Maximum voltage, V	Rated operational current, A			Enclosure material
					AC-12*	AC-15*	DC-13*	
PGEZ1Z		1NO+1N3	Key	400AC 400DC	10 (at 400V) 16 (at 250V) 16 (at 120V) 16 (at 24V) 16 (at 12V)	6 (at 400V) 10 (at 250V) 16 (at 120V)	0,5 (at 250V) 1 (at 110V) 2 (at 24V) 2 (at 12V)	plastic
PGEZ1W		1NO+1N3						
PGEPKL2I		2NO	Switch					
PGEPKL1Z		1NO+1N3						

*Application in other groups is permitted, ratings depend on the code of the category of application.

TECHNICAL CHARACTERISTICS OF PTC... POTENTIOMETER

Type	Resistance, Ω	Consumed power, W	Enclosure material
PTCE1	1000	1	plastic
PTCE2	2000		
PTCE5	5000		
PTCE10	10000		

TECHNICAL CHARACTERISTICS OF PGS TIPE SIRENS

Type	Sound pressure, dB	Maximum voltage, V	Rated operational current, A	Enclosure
PSGE01	108	12DC	0,15	Plastic

OPERATION IN ACCORDANCE WITH STANDARDS

Control, indication and sound alarm components are used as part of equipment of stationary and portable electrical installations inside and outside production facilities.



SOLUTIONS FOR CONTROL STATIONS

Ultra-high mechanical and corrosion resistance

Lifespan of the flameproof joint is over 25 years

Highly resistant to hydrogen sulfide exposure

Easily replaceable contact modules and light sources



- High resistance to hydrogen sulfide exposure
- Service life of flameproof joints is more than 25 years
- Sunk position of an operating handle denies accidental switching in case of dropping of different objects or ice from the racks
- Large size allows to work in gloves (important for outdoor operation at low temperatures)
- Overheating and further malfunctioning of electromechanical components is impossible due to specially selected switching equipment with insulating materials of higher quality

MATERIALS

- Enclosure and cover of PPG...control stations are made from aluminum alloy with magnesium content not more than 1%.
- Fastening bolts of the cover and internal and external ground bolts are made for stainless steel.
- Coating of aluminum alloy enclosures of control stations: powder paint.
- For separation of volumes by compound encapsulation, PG-COMPOUND shall be used.
- Material of cable glands and built-in components is according to manufacturer's documentation.

CERTIFICATION DATA

Zones for installation

Zone 1 - Zone 2 (Gas)

Zone 21 - Zone 22 (Dust)

Version

IECEX
Ex db IIB T6...T5 Gb
Ex db IIC T6...T5 Gb
Ex tb IIIC T56°C... T90°C Db



PPG-25..., PPG-63..., PPG-80... control stations

ATEX
⊕ II 2 G Ex db IIB T6...T5 Gb
⊕ II 2 G Ex db IIC T6...T5 Gb
⊕ II 2 D Ex tb IIIC T56°C...T90°C Db

Certification

IECEX CCVE 18.0009X

All **IECEX** and **ATEX** certification data can be downloaded from www.en.exd.ru

EESF 19 ATEX 029X

Conformance standards

Control stations are manufactured in accordance with Directive 2014/34/EU ATEX standards and conform to them, IEC 60079-0: 2011, IEC 60079-1: 2014, 60079-7:2015, IEC 60079-18:2014, IEC 60079-31: 2013, EN 60079-0: 2012, EN 60079-1: 2014, EN 60079-7:2015, EN 60079-18:2014, EN 60079-31: 2014.

Permissible Ambient temperature range

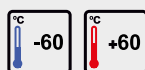

Alternating current frequency, Hz

50/60

TECHNICAL CHARACTERISTICS OF CONTROL STATIONS

Product name	Maximum voltage, V	Maximum operating current
PPG-25 on the base of PKIVA111112 enclosure	400 AC 400 DC	25 A
PPG-63 on the base of PKIVA148 enclosure		63 A
PPG-80 on the base of PKIVA148 enclosure		80 A

FORMATION OF MARKING

Structure of designation of PPG... control stations:

PPG – X2X3 – X4X5/X6, where

- └ «PPG» – product name;
- └ «X2» – type of diagram ;
- └ «X3» – current;
- └ «X4» – number of cable glands (no more than two, if any);
- └ «X5» – type of cable gland (if any);
- └ «X6» – options, accessories and versions (refer to table «Designation of options, accessories, version and its description».

STRUCTURAL PARAMETERS OF PPG... CONTROL STATIONS

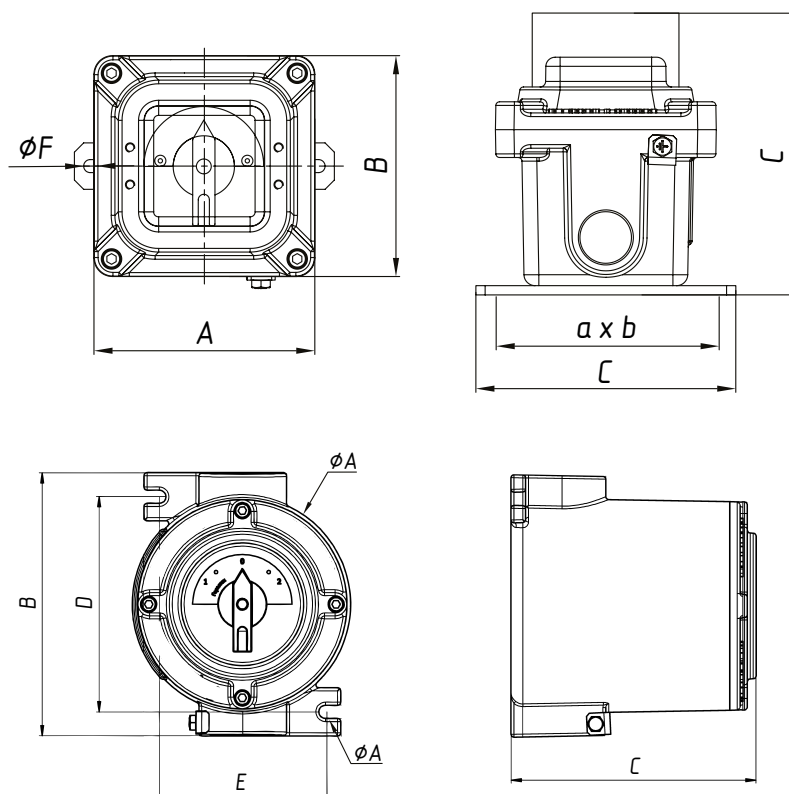

Type of control station	Dimensions, mm								
	Outer			Inner			Fastening		
	A	B	C	a	b	c	D	F	E
PPG... on the base of PKIVA111112 enclosure	276,5	276,5	218	248	248	169	236	316	14
PPG... on the base of PKIVA148 enclosure	119	119	150	55	77	89	-	7	120

Overall dimensions may change depending on installed cable glands and control elements.



Cable glands available on page 124

TYPE OF DIAGRAMS OF PPG... CONTROL STATIONS FOR RATED OPERATING CURRENT 25 A, 63 A AND 80 A

Type	Rated Current	Closing diagram	Nos. Of poles	Description
PPG-1I25	25		1	Two-position switch with zero position, (0-1)
PPG-2I25	25		2	Two-position switch with zero position, (0-1)
PPG-2I63	63			
PPG-2I80	80			
PPG-3I25	25		3	Two-position switch, (0-1)
PPG-3I63	63			
PPG-3I80	80			
PPG-4I25	25		4	Two-position switch with zero position, (0-1)
PPG-1S25	25		1	Three-position switch with zero position, (0-1-2)
PPG-1S63	63			
PPG-1S80	80			
PPG-2S25	25		2	Three-position switch with zero position, (0-1-2)

Type	Rated Current	Closing diagram	Nos. Of poles	Description
PPG-3S25	25		3	Three-position switch with zero position, (0-1-2)
PPG-1Z25	25		1	Two-position switch without zero position, (1-2)
PPG-1Z63	63			
PPG-1Z80	80			
PPG-2Z25	25		2	Two-position switch without zero position, (1-2)
PPG-3Z25	25		3	Two-position switch without zero position, (1-2)
PPG-1V25	25		3	Three-position switch for voltmeter without zero position, angle of rotation 45°
PPG-2V25	25		3	Four-position switch for voltmeter with zero position, angle of rotation 30°, 3 linear voltages

Type	Rated Current	Closing diagram	Nos. Of poles	Description
PPG-3V25	25		3	Four-position switch for voltmeter with zero position, angle of rotation 45°
PPG-4V25	25		3	Seven-position switch for voltmeter without zero position, angle of rotation 30°
PPG-5V25	25		3	Seven-position switch for voltmeter with zero position, angle of rotation 45°
PPG-6V25	25		3	Four-position switch for voltmeter with zero position, angle of rotation 30°, 3 phase voltages
PPG-1A25	25		1	Switch for ammeter for three transformer's circuits with zero position, angle of rotation 90°











- Flexible system of modulation based on one-, two-, three- or multi-button enclosures
- Ultra-high mechanical and corrosion resistance of explosion-proof pins in control elements
- Easily replaceable contact modules and light sources
- Highly resistant to hydrogen sulfide exposure
- Lifespan of the flameproof joint is over 25 years

MATERIALS

- Enclosure and cover of PKIVA... control stations are made from aluminum alloy with magnesium content not more than 1%.
- Fastening bolts of the cover and internal and ex-ternal ground bolts are made for stainless steel.
- Coating of aluminum alloy enclosures of control sta-tions: powder paint.

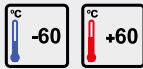
CERTIFICATION DATA

Zones for installation		
Zone 1 - Zone 2 (Gas)	Zone 21 - Zone 22 (Dust)	
Version		
IECEX	Ex db IIB T6...T5 Gb Ex db IIC T6...T5 Gb Ex db eb mb IIB T6...T5 Gb Ex db eb mb IIC T6...T5 Gb Ex tb IIIC T51°C... T100°C Db	 PKIVA... control stations
ATEX	 II 2 G Ex db IIB T6...T5 Gb  II 2 G Ex db IIC T6...T5 Gb  II 2 G Ex db eb mb IIB T6...T5 Gb  II 2 G Ex db eb mb IIC T6...T5 Gb  II 2 D Ex tb IIIC T51°C... T100°C Db	
Certification		
IECEX CCVE 18.0009X	All IECEX and ATEX certification data can be downloaded from www.en.exd.ru	
EESF 19 ATEX 029X		
Conformance standards		
Control stations are manufactured in accordance with Directive 2014/34/EU ATEX standards and conform to them, IEC 60079-0: 2011, IEC 60079-1: 2014, 60079-7:2015, IEC 60079-18:2014, IEC 60079-31: 2013, EN 60079-0: 2012, EN 60079-1: 2014, EN 60079-7:2015, EN 60079-18:2014, EN 60079-31: 2014.		
Ambient temperature (T _{amb})	Maximum voltage, V	Alternating current frequency, Hz
		

TECHNICAL CHARACTERISTICS OF CONTROL STATIONS

Product name	Maximum voltage, V	Maximum operating current
PKIVA	400 AC 400 DC	16 A

FORMATION OF MARKING

Individual marking plates are applied to the control stations, which contain as minimum:

- product type;
- name of the manufacturer or its registered trademark;
- European conformity mark with certification body number;
- Ex-marking;
- serial number;
- ambient temperature range;
- number(s) of the certificates or a logo of the body;
- electric parameters;

and other functional data required by regulatory and technical documentation, which shall be specified in the marking by the manufacturer.

Structure of designation of PKIVA... control stations:

PKIVAX1X2 - X3 - X4X5 - X4X5 - ... - X6X7 - X6X7 - ... / X8, where

- └ «PKIVA» - product name;
- └ «X2» - code of size of product's enclosure;
- └ «X3» - code of window size (for products with window);
- └ «X4» - number of control element (if any);
- └ «X5» - type of control element (if any);
- └ «X6» - number of cable glands (if any);
- └ «X7» - type of cable gland (if any);
- └ «X8» - options, accessories and versions.

APPEARANCE AND STRUCTURAL PARAMETERS OF CONTROL STATIONS MADE ON THE BASE OF PKIVA... ENCLOSURES

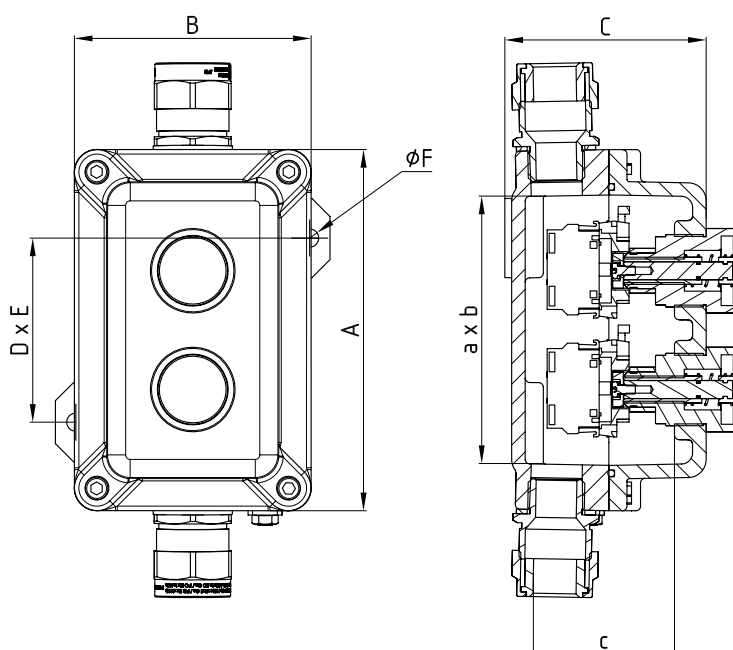

Type of control station	Dimensions, mm								
	Outer			Inner			Fastening		
	A	B	C	a	b	c	D	F	E
PKIVA101008	105	105	89	63	63	66	113	7	-
PKIVA161008	160	105	89	119	64	66	103	8	81.3
PKIVA111112	119	119	128	77	77	87	-	-	-
PKIVA211108	200	116	86	155	61	57	113	8	121

Overall dimensions of control stations may change depending on dimension type of the box, installed cable glands and control elements.



Cable glands available on page 124



Ex d control and indicating elements available on page 43

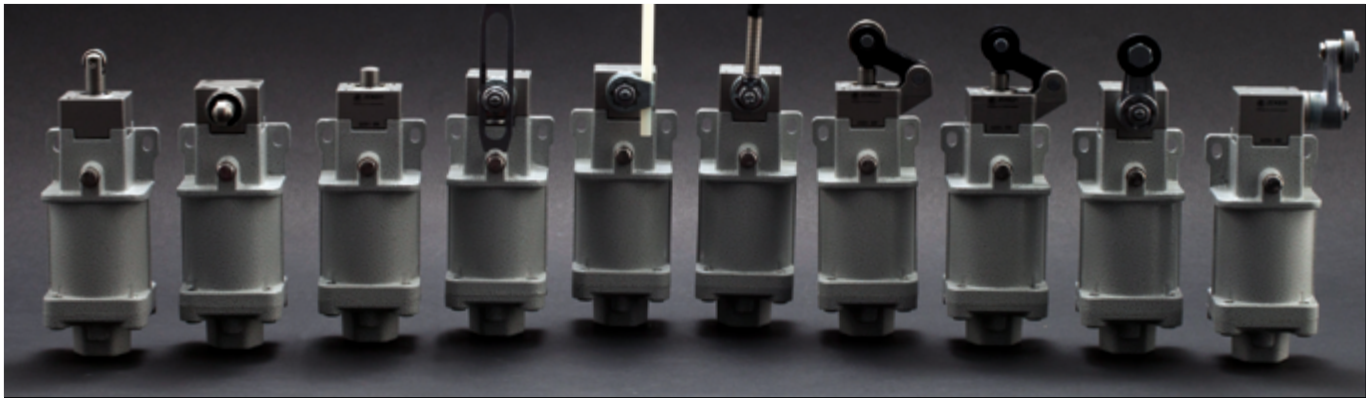

- Schneider Electric heads series Telemecanique with improved reliability
- Up to 10 A current switching available
- Electrically separated contacts
- Accurate regulation of the trigger
- Highly resistant to mechanical impact and vibration
- Highly resistant to aggressive atmospheres and salt spray
- Based on principle of breaking electrical supply circuit by contact block in case of contact with limiter





MATERIALS

- Material of the enclosure and cover – aluminium alloy.
- Material of the sealing ring – silicone.
- Material of the sealant - lubricant PG-SMAZKA-VTV.
- Enclosure has external protective anti-frictional coating which corresponds to the requirements of IEC 60079-0:2011, EN 60079-0:2012, IEC 60079-1:2014, EN 60079-1:2014

CONFORMITY TO STANDARDS

Limit switches DVG-KV are manufactured in accordance with the requirements IEC 60079-0: 2011, IEC 60079-1: 2014, IEC 60079-31: 2013, EN 60079-0: 2012, EN 60079-1: 2014, EN 60079-31: 2014, Directive 2014/34/EU ATEX standards and conform to them.

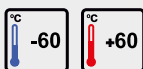
CERTIFICATION DATA

Zones for installation	
Zone 1 - Zone 2 (Gas)	Zone 21 - Zone 22 (Dust)
Version	
IECEX Ex db IIC T6 Gb Ex tb IIIC T70°C Db	 DVG...limit switches
ATEX  II 2 G Ex db IIC T6 Gb  II 2 D Ex tb IIIC T70°C Db	
Certification	
IECEX CCVE 18.0011X	All IECEX and ATEX certification data can be downloaded from www.en.exd.ru
EESF 19 ATEX 024X	
Conformance standards	
Plugs and sockets are manufactured in accordance with the requirements of Directive 2014/34/EU ATEX standards and conform to them, IEC 60079-0: 2011, IEC 60079-1: 2014, IEC 60079-31: 2013, EN 60079-0: 2012, EN 60079-1: 2014, EN 60079-31: 2014.	
Technical characteristics	
24V AC – 50/60Hz, 10A; 120V AC – 50/60Hz, 6A; 230V AC – 50/60Hz, 3.1A; 240V AC – 50/60Hz, 3A; 400V AC – 60/50Hz, 1.8A; 24V DC - 2.8A; 125V DC - 0.55A; 250V DC - 0.27A	
Permissible Ambient temperature range	Alternating current frequency, Hz
	

FORMATION OF MARKING

DVG-KV - X2 X3 - X4 / X5

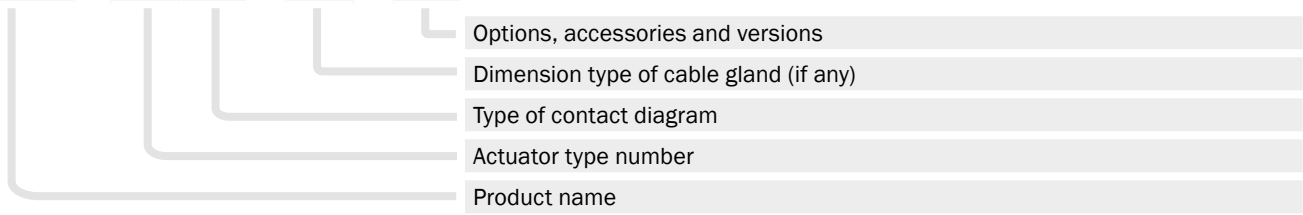



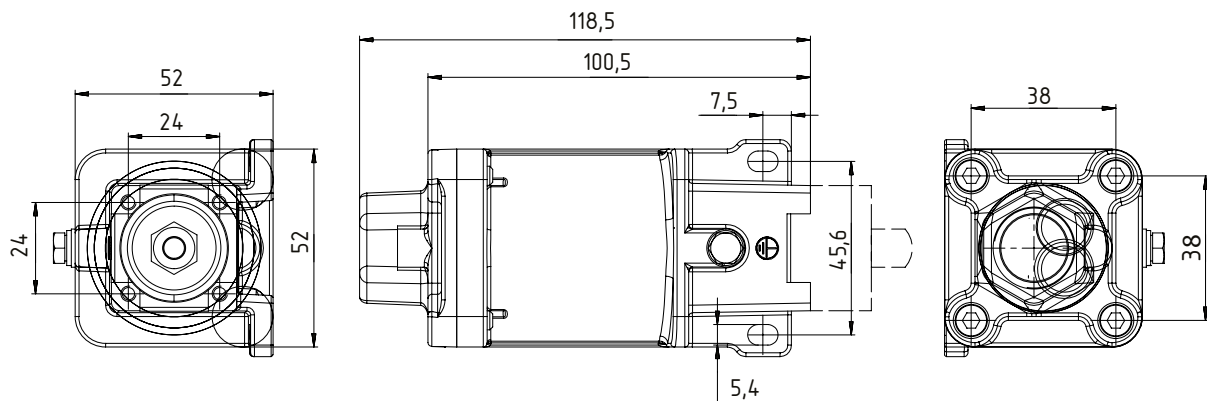



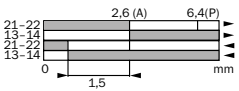
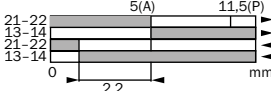
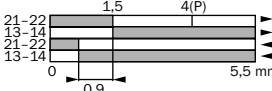
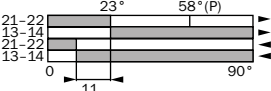

DESIGN PARAMETERS OF DVG

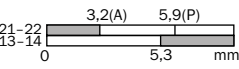
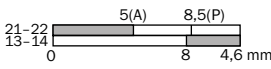
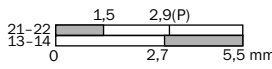
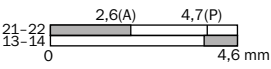

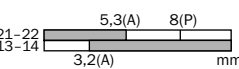
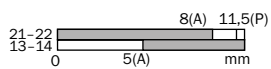
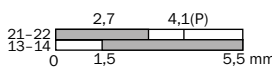
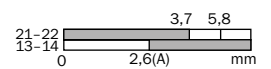
TYPE CONFIGURATIONS OF DVG-KV DEVICES

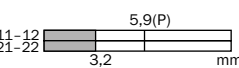
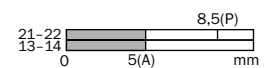
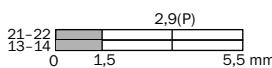
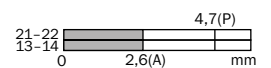
Connection diagram	Explosion-proof limit switches		
	DVG-KV-E41, DVG-KV-E42, DVG-KV-E51, DVG-KV-E52, DVG-KV-E62, DVG-KV-E71, DVG-KV-E73	DVG-KV-E11, DVG-KV-E12	
K1 Snap-action contact 1NO+1NC			
K2 Contact with opening, before closing 1NO+1NC			
K3 Contact with closing, before opening 1NO+1NC			
K4 Delay action contact 2NC			
K5 Delay action contact 2NO			

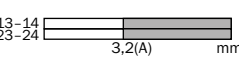
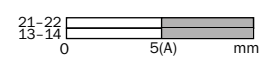
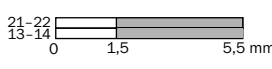
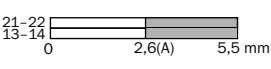
Connection diagram	Explosion-proof limit switches			
	DVG-KV-E13	DVG-KV-E31, DVG-KV-E32	DVG-KV-E21	DVG-KV-E22
K1 Snap-action contact 1NO+1NC 				
K2 Contact with opening, before closing 1NO+1NC 				
K3 Contact with closing, before opening 1NO+1NC 				
K4 Delay action contact 2NC 				
K5 Delay action contact 2NO 				



Cable glands available on page 124



- Explosion-proof enclosures with window are applied for KIP devices as well as for visual control equipment, including monitors and displays mounted in hazard zones, aggressive atmospheres and for general industrial use

MATERIALS

- Enclosure and cover of KV... control stations are made from aluminum alloy with magnesium content not more than 1%.
- Fastening bolts of the cover and internal and external ground bolts are made for stainless steel.
- Coating of aluminum alloy enclosures of control stations: powder paint.





CERTIFICATION DATA

Zones for installation

Zone 1 - Zone 2 (Gas)

Zone 21 - Zone 22 (Dust)

Version

IECEX	Ex db IIB T6...T5 Gb Ex db IIC T6...T5 Gb Ex tb IIIC T51°C... T100°C Db		KV... control station
ATEX	 II 2 G Ex db IIB T6...T5 Gb  II 2 G Ex db IIC T6...T5 Gb  II 2 D Ex tb IIIC T51°C... T100°C Db		

Certification

IECEX CCVE 18.0009X

All **IECEX** and **ATEX** certification data can be downloaded from www.en.exd.ru

EESF 19 ATEX 029X

Conformance standards

Control stations are manufactured in accordance with Directive 2014/34/EU ATEX standards and conform to them, IEC 60079-0: 2011, IEC 60079-1: 2014, 60079-7:2015, IEC 60079-18:2014, IEC 60079-31: 2013, EN 60079-0: 2012, EN 60079-1: 2014, EN 60079-7:2015, EN 60079-18:2014, EN 60079-31: 2014.

Permissible Ambient temperature range

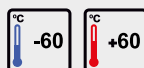

Alternating current frequency, Hz

50/60

Push button control stations, indication and signaling units can be applied in intrinsically safe circuits for circuit switching.

TECHNICAL CHARACTERISTICS

Product name	Maximum voltage, V	Maximum operating current
KV...	<div style="display: flex; gap: 10px;"> <div style="border: 1px solid black; padding: 2px;">800 AC*</div> <div style="border: 1px solid black; padding: 2px;">600 DC</div> </div>	<div style="border: 1px solid black; padding: 2px;">25 A*</div>

*Maximum values of current and voltage during overload: 50 A and 1600 V.

FORMATION OF MARKING

Individual marking plates are applied to the control stations, which contain as minimum:

- product type;
- name of the manufacturer or its registered trademark;
- European conformity mark with certification body number;
- Ex-marking;
- serial number;
- ambient temperature range;
- number(s) of the certificates or a logo of the body;
- electric parameters;

and other functional data required by regulatory and technical documentation, which shall be specified in the marking by the manufacturer.

Structure of designation of KV... control stations:

KV - X2X3 - X4 - X5X6 /X7, where

- └ «KV» - product name;
- └ «X2» - shortened functional purpose;
- └ «X3» - code of size of product's enclosure;
- └ «X4» - code of window size (for products with window, if any);
- └ «X5» - number of cable glands (no more than two) (if any);
- └ «X6» - type of cable gland (if any);
- └ «X7» - options, accessories and versions.

STRUCTURAL PARAMETERS OF KV... CONTROL STATIONS

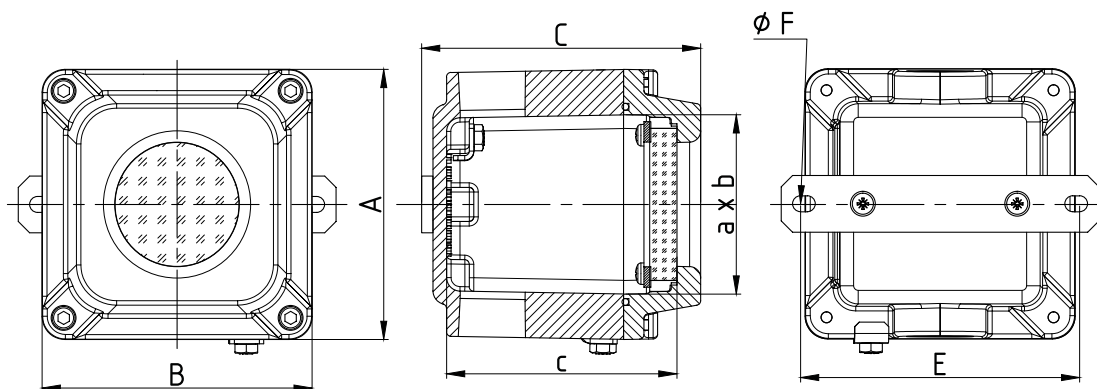

Type of control station	Dimensions, mm									
	Outer			Inner			Fastening			Standard dimension of window
	A	B	C	a	b	c	D	F	E	Ø
KV-KIP111112-005	119	119	123	55	77	89	-	7	120	55

Overall dimensions of control stations may change depending on dimension type of the box, installed cable glands and control elements.



Cable glands available on page 124



LIGHTING EQUIPMENT

Highly resistant to impact loads

Extended lifespan

Various types of lamps available

Various types of mounting available



SGJ01...-S

- New generation of high-efficient super bright LED's with luminous flux ~115 lm per 1 W
- Highly resistant to impact loads
- Various types of mounting available
- Spring-loaded sliding contacts technology in junction box allows to avoid twisting conductors so to simplify mounting, maintenance and assembling
- Light lifespan equals the lifespan of its enclosure which is 25 years.



SGJ01 E27

- Various types of lamps available:
 - LED with base,
 - incandescent,
 - compact fluorescent (incl. spiral) lamp, halogen,
 - mixed type
- Various types of mounting available
- Spring-loaded sliding contacts technology in junction box allows to avoid twisting conductors so to simplify mounting, maintenance and assembling
- Supplied with a socket for E27 base

MATERIALS

- The enclosure is made from aluminum alloy.
- Light transmitting cover is made from tempered glass.
- Light transmitting cover is protected by grid.

CERTIFICATION DATA

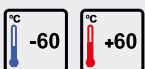
Zones for installation		
Zone 1 - Zone 2 (Gas)	Zone 21 - Zone 22 (Dust)	
Version		
IECEX Ex db IIC T6...T5 Gb Ex tb IIIC T52°C ...T95°C Db	 SGJ01 with an LED unit	
ATEX ⊕ II 2 G Ex db IIC T6...T5 Gb ⊕ II 2 D Ex tb IIIC T52°C ...T95°C Db		
IECEX Ex db IIC T6...T3 Gb Ex tb IIIC T57°C ...T158°C Db	 SGJ01 series light fixtures for various types of lamps with E27 sockets	
ATEX ⊕ II 2 G Ex db IIC T6...T3 Gb ⊕ II 2 D Ex tb IIIC T57°C ...T158°C Db		
Certification		
IECEX CCVE 18.0010X	All IECEX and ATEX certification data can be downloaded from www.en.exd.ru	
EESF 19 ATEX 014X		
Conformance standards		
Light fixture series SG... are manufactured in accordance with Directive 2014/34/EU ATEX standards and conform to them, IEC 60079-0: 2011, IEC 60079-1: 2014, IEC 60079-31: 2013, EN 60079-0: 2012, EN 60079-1: 2014, EN 60079-31: 2014.		
Permissible Ambient temperature range	Supply voltage	Electric diagram
	10-36DC; 110-230AC	Direct connection to L, N, PE terminals with cross-section 1,5-4 mm ² Screw terminals I _{max} - 16 A are installed.

OVERALL DIMENSIONS

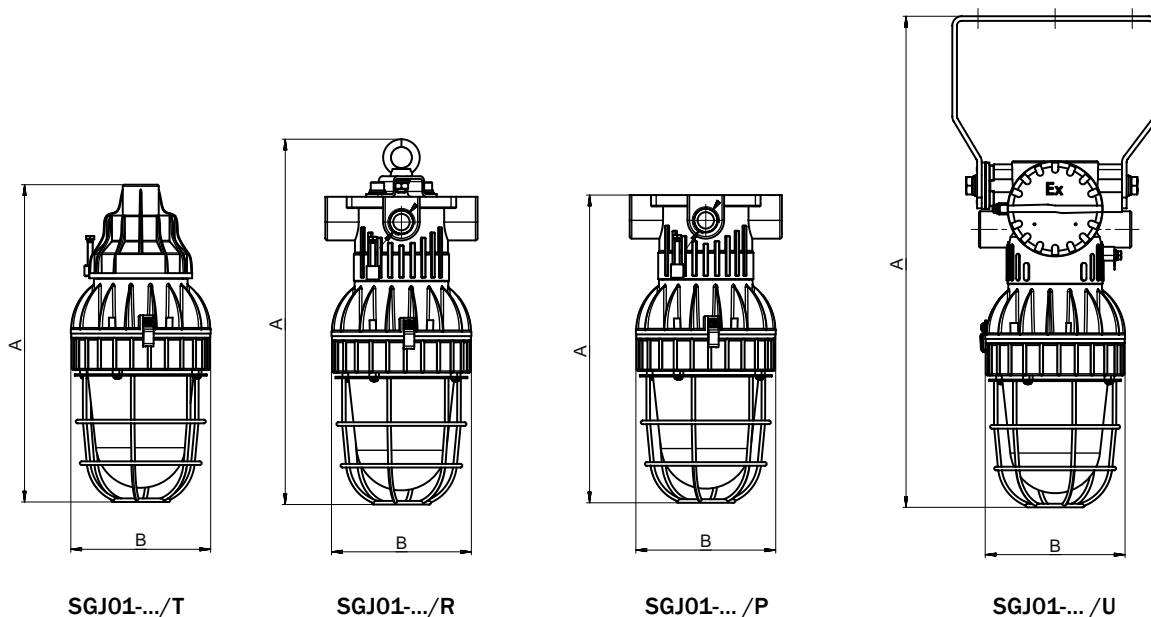

SGJ01-.../T

SGJ01-.../R

SGJ01-... /P

SGJ01-... /U

Enclosure type	Type of mounting	Size*, mm	
		A	B
SGJ1.1	pipe mounting - T	309	136
SGJ1.2		352	201
SGJ1.1	suspension mounting (with eye bolt) - R	355	136
SGJ1.2		403	201
SGJ1.1	ceiling mounting - P	299	136
SGJ1.2		347	201
SGJ1.1	universal swivel mounting - U	478	136
SGJ1.2		524	201

*Limit deviations in sizes: ± 15 mm.

TECHNICAL CHARACTERISTICS OF THE LIGHT FIXTURES SERIES SGJ01-... WITH AN LED UNIT

Model	Maximum luminous flux of the light source, lm	Installed power Pinst, W	Temperature class	Recommended type of enclosure*
SGJ01-1240S	1240	9,6	T6	SGJ1.1
SGJ01-2480S	2480	18,5	T6	SGJ1.1
SGJ01-3720S	3720	28,5	T6, T5	SGJ1.1
SGJ01-4960S	4960	40,7	T6	SGJ1.2
SGJ01-6200S	6200	48	T6	SGJ1.2
SGJ01-7440S	7440	57	T6, T5	SGJ1.2
SGJ01-11160S	11160	85,5	T6, T5	SGJ1.2

*If required, it can be changed to larger dimension type.

TECHNICAL CHARACTERISTICS OF SGJ01... SERIES LIGHT FIXTURES FOR VARIOUS TYPES OF LAMPS WITH E27 AND E40 SOCKETS

Model	Maximum lamp power*, W	Temperature class	Recommended type of enclosure
SGJ01-XINC	75	T6, T5, T4	SGJ1.1
SGJ01-XINC	150	T5, T4	SGJ1.1
SGJ01-XINC	200	T4, T3	SGJ1.1
SGJ01-XINC	75	T6, T5	SGJ1.2
SGJ01-XINC	95	T6, T5	SGJ1.2
SGJ01-XINC	200	T5, T4	SGJ1.2
SGJ01-XINC	300	T3	SGJ1.2
SGJ01-XAI	70	T6, T5, T4	SGJ1.1
SGJ01-XAI	150	T4, T3	SGJ1.1
SGJ01-XAI	205	T4, T3	SGJ1.1
SGJ01-XAI	100	T6, T5	SGJ1.2
SGJ01-XAI	205	T4	SGJ1.2
SGJ01-XEI	25	T6, T5	SGJ1.1
SGJ01-XEI	25	T6	SGJ1.2
SGJ01-XEI	55	T6, T5	SGJ1.2
SGJ01-XFIL	23	T6	SGJ1.2
SGJ01-XLED	15	T6	SGJ1.1
SGJ01-XLED	20	T6, T5	SGJ1.1
SGJ01-XLED	20	T6	SGJ1.2
SGJ01-XLED	30	T6	SGJ1.2
SGJ01-XMix	160	T4	SGJ1.2

Lamp types	
INC	incandescent lamp
AI	halogen lamp
EI	compact fluorescent lamp
FIL	fluorescent induction lamp
LED	LED lamp
Mix	mixed light instant start lamp

*Where X is lamp's power. Structure of designation of light fixtures includes actual power of lamps which does not exceed indicated maximum value depending on operating temperature and temperature class.



Cable glands available on page 124

FORMATION OF MARKING

SGJ01X2 - X3X4 - X5/X6 - X7/X8, where

- └ «SGJ01» - light fixture series;
- └ «X2» - type number: 01;
- └ «X3» - power or maximum luminous flux;
- └ «X4» - type of light source:
 - SGJ01 with LED unit: S - LED unit;
 - SGJ01 with socket lamp type: INC - incandescent lamp; AI - halogen lamp; LK - compact, fluo-rescent lamp; FIL - fluorescent induction lamp; LED - LED lamp, Mix - mixed light instant start lamp;
- └ «X5» - designation of supply voltage: 12DC - 10...36V DC; 220AC - 110...230V AC;
- └ «X6» - type of mounting: pipe mounting - T; suspension mounting (with eye bolt) - R; ceiling mounting - P; universal swivel mounting - U;
- └ «X7» - Quantity and dimension type of cable glands, additionally side of their arrangement can be indicated (Metric ISO 965-1 and ISO 965-3: M12÷M32x1,5; British Standard Pipe Parallel Thread ISO R228: 1/16" ÷ 1"G; National Standard Taper Pipe Thread ANSI/ASME B1.20.1: 1/16" ÷ 1"NPT);
- └ «X8» - options, accessories and versions (if any).



- Resistant to constant exposure of aggressive atmospheres, including hydrogen sulfide vapors and UV radiation
- Operation period in emergency mode – 60–90 minutes
- Can be manufactured with stainless steel
- Lamp shade cover is made from heat- and impact-resistant glass
- May be used at ambient temperature from –60°C
- The body has two entries for installation of explosion-proof cable glands.
- Structural features and materials enable to continuously protect LEDs from the exposure of aggressive chemical substances at the customers sites during the whole period of operation.

MATERIALS

- Material of the cover – tempered glass.
- Material of the enclosure – stainless steel.
- Material of the sealing ring – silicone.
- Material of the sealant – compound PG-COMPOUND, lubricant PG-REZBA-F.

CERTIFICATION DATA

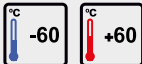
Zones for installation			
Zone 1 - Zone 2 (Gas)		Zone 21 - Zone 22 (Dust)	
Version			
IECEX	Ex eb mb op is IIC T6...T4 Gb		SGL01...
ATEX	II 2 G Ex eb mb op is IIC T6...T4 Gb		
Certification			
IECEX CCVE 19.0006X		All IECEX and ATEX certification data can be downloaded from www.en.exd.ru	
EESF 19 ATEX 072X			
Conformance standards			
Light fixture series SGL01... are manufactured in accordance with standards and conform to them, IEC 60079-0:2011, IEC 60079-7:2015, IEC 60079-18:2014, IEC 60079-28:2015, EN 60079-0:2012, EN 60079-7:2015, EN 60079-18:2014, EN 60079-28:2015.			
Permissible Ambient temperature range		Supply voltage	
		10-36DC; 110-230AC; 110-230DC	

OVERALL DIMENSIONS

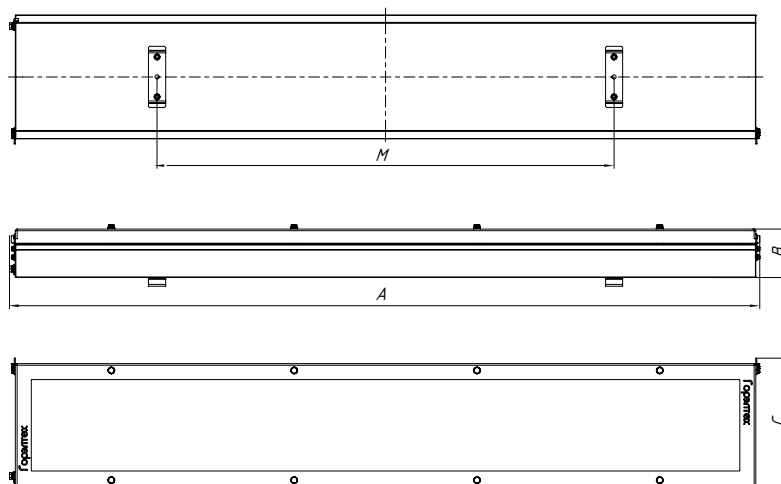

Enclosure type	Size*, mm			
	A	B	C	M
SGL1.1	710	125	225	500
SGL1.2	1310	125	225	800

*Limit deviations in sizes: ± 15 mm.

TECHNICAL CHARACTERISTICS OF THE LIGHTING FIXTURE SERIES SGL01...

Model	Maximum luminous flux of the light source, lm	Installed power Pinst, W	Temperature class	Recommended type of enclosure*
SGL01-2480S	2480	18,5	T6, T5	SGL1.1
SGL01-4960S	4960	37	T6, T5, T4	SGL1.2

*If required, it can be changed to larger dimension type.



Cable glands available on page 124

FORMATION OF MARKING

SGLX2 - X3X4 - X5/X6/X7 - X8 X9, where

- └ «SGL» - light fixture series;
- └ «X2» - type number: 01;
- └ «X3» - maximum luminous flux;
- └ «X4» - type of light source: S - LED unit;
- └ «X5» - designation of supply voltage: 12DC - 10...36V DC; 220AC - 110...230B AC; 220DC - 110...230B DC;
- └ «X6» - material enclosure: stainless steel - N;
- └ «X7» - type of mounting: pipe mounting - T; suspension mounting (with eye bolt) - R; ceiling mounting - P; wall mounting 45° - S45;
- └ «X8» - quantity and dimension type of cable glands (if any);
- └ «X9» - options, accessories and versions (if any).

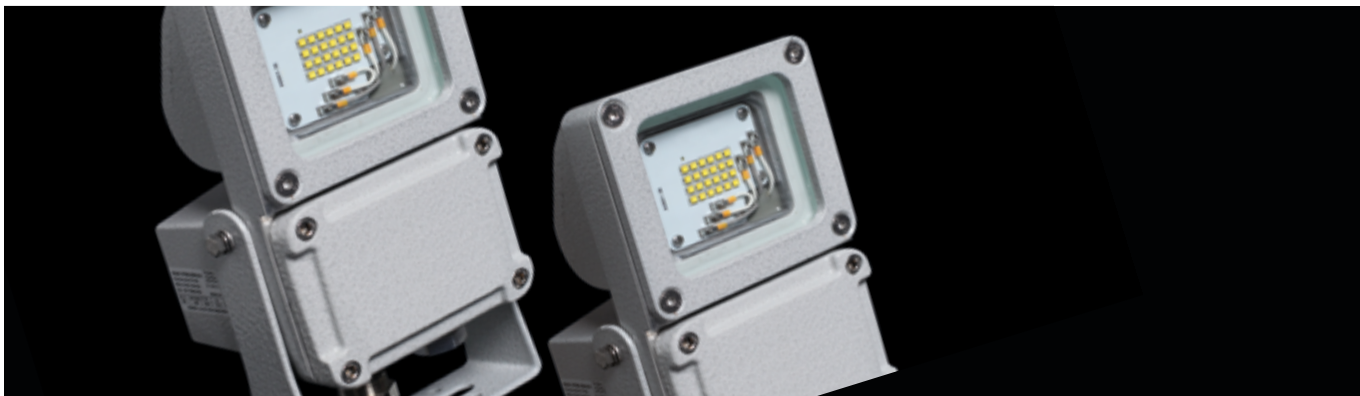

- Impact- and heat-resistant glass provides high light transmission and mechanical resistance
- Original design with a radiator provides high heat transfer
- Aluminum alloy provides high resistance to the exposure of hydrogen sulfide
- Sealed and air-filled chamber for LED plates prevents exposure of dust, moist, aggressive atmospheres and gases (e.g. hydrogen sulfide), avoiding condensation in case of changes in temperature and humidity
- Modular lighting devices of various configuration available on SGU01-...LED base:
 - single-row 2-5 SGU01-...S light fixtures
 - double-row 4-10 SGU01-...S light fixtures

MATERIALS

- Material of light reflecting part – tempered glass.
- Material of enclosure – aluminum alloy.
- Material of sealing ring – silicone.
- Material of sealant – PG-REZBA-F sealant, PG-COMPOUND compound.
- The enclosure has external protective antifriction coating which conforms to the requirement of IEC 60079-0: 2011, EN 60079-1: 2014

CERTIFICATION DATA

Zones for installation

Zone 1 - Zone 2 (Gas)

Zone 21 - Zone 22 (Dust)

Version

IECEX

Ex db eb mb IIC T6...T4 Gb
Ex tb IIIC T53°C...101°C Db



SGU01...

ATEX

II 2 G Ex db eb mb IIC T6...T4 Gb
II 2 D Ex tb IIIC T53°C ...T101°C Db

Certification

IECEX CCVE 18.0012X

All **IECEX** and **ATEX** certification data can be downloaded from www.en.exd.ru

EESF 19 ATEX 033X

Conformance standards

Light fixture series SGU01... are manufactured in accordance with standards and conform to them, IEC 60079-0:2011, IEC 60079-1:2014, IEC 60079-7:2015, IEC 60079-18:2014, IEC 60079-31:2013, EN 60079-0:2012, EN 60079-1:2014, EN 60079-7:2015, EN 60079-18:2014, EN 60079-31:2014 standards.

Permissible Ambient temperature range

Supply voltage



10-36DC; 110-230AC

OVERALL DIMENSIONS OF SGU01 LIGHT FIXTURES WITH PIPE MOUNTING

SGU01-1240S/T, SGU01-2480S/T, SGU01-3720S/T

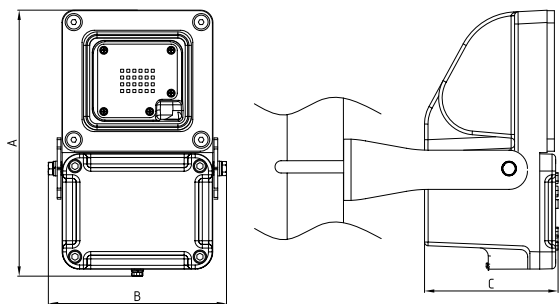

SGU01-4960S/T, SGU01-7440S/T, SGU01-9920S/T

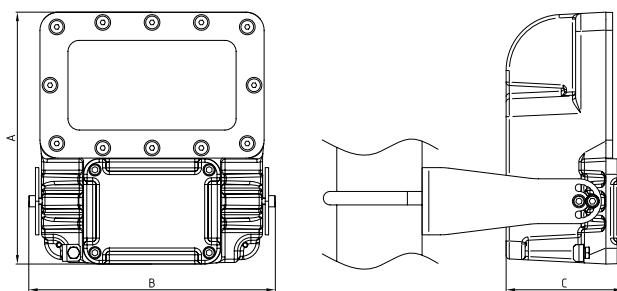

SGU01-14880S/T, SGU01-19840S/T, SGU01-24800S/T

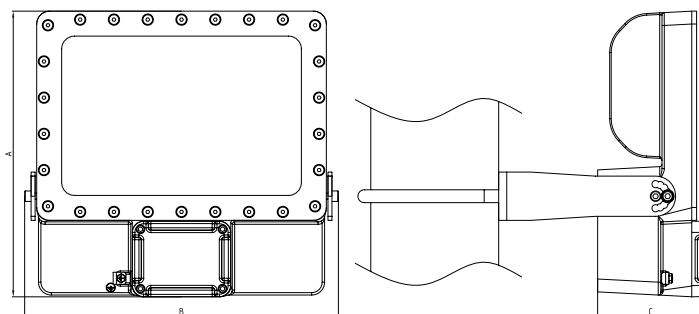

OVERALL DIMENSIONS OF LIGHT FIXTURES WITH UNIVERSAL MOUNTING

SGU01-1240S/U, SGU01-2480S/U, SGU01-3720S/U

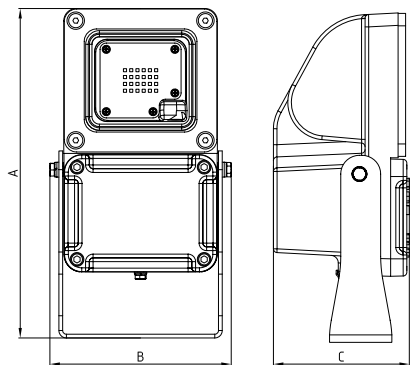

SGU01-4960S/U, SGU01-7440S/U, SGU01-9920S/U

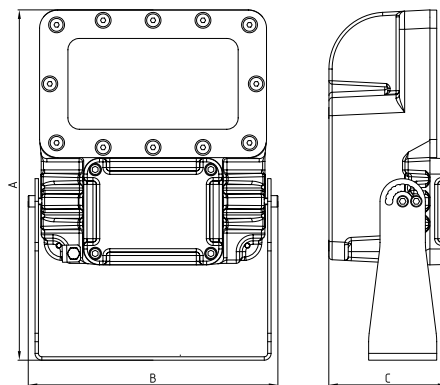

SGU01-14880S/U, SGU01-19840S/U, SGU01-24800S/U

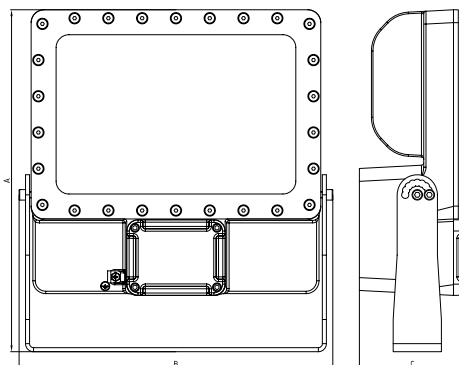

OVERALL DIMENSIONS OF ENCLOSURES

Enclosure type	Type of mounting	Size*, mm		
		A	B	C
VSP4-1	pipe mounting - T	217	123	109
	universal swivel mounting - U	264	145	109
VSP4-2	pipe mounting - T	225	226	104
	universal swivel mounting - U	309	220	104
VSP4-3	pipe mounting - T	355	397	132
	universal swivel mounting - U	425	390	132

*Permissible deviations in sizes: ± 15 mm

TECHNICAL CHARACTERISTICS OF SGU01... LIGHT FIXTURES

Model	Maximum luminous flux of the light source, lm	Installed power Pinst, W	Temperature class	Recommended type of enclosure
SGU01-1240C-12DC	1240	9,6	T6	VSP4-1
SGU01-1240C-220AC	1240	9,6	T6	VSP4-1
SGU01-2480C-12DC	2480	18,5	T6	VSP4-1
SGU01-2480C-220AC	2480	18,5	T6	VSP4-1
SGU01-3720C-12DC	3720	28,5	T6	VSP4-1
SGU01-3720C-220AC	3720	28,5	T6	VSP4-1
SGU01-4960C-12DC	4960	37	T6	VSP4-2
SGU01-4960C-220AC	4960	37	T6	VSP4-2
SGU01-7440C-12DC	7440	59	T6, T5	VSP4-2
SGU01-7440C-220AC	7440	59	T6, T5	VSP4-2
SGU01-9920C-12DC	9920	71	T6, T5	VSP4-2
SGU01-9920C-220AC	9920	71	T6, T5	VSP4-2
SGU01-14880C-12DC	14880	110	T6, T5	VSP4-3
SGU01-14880C-220AC	14880	110	T6, T5	VSP4-3
SGU01-19840C-12DC	19840	147	T6, T5	VSP4-3
SGU01-19840C-220AC	19840	147	T6, T5	VSP4-3
SGU01-24800C-12DC	24800	184	T6, T5, T4	VSP4-3
SGU01-24800C-220AC	24800	184	T6, T5, T4	VSP4-3



Cable glands available on page 124

FORMATION OF MARKING

SGU01 - X2X3 - X4/X5 - X6/X7, where

- └ «SGU01» – light fixture;
- └ «X2» – maximum luminous flux of the installed LED matrix, lm: SGU01: 1240, 2480, 3720, 4960, 7440, 9920, 14880, 19840, 24800;
- └ «X3» – type of the light source: S – LED matrix;
- └ «X4» – supply voltage designation: 12DC – 10...36V DC, 220AC - 110...230V AC;
- └ «X5» – type of mounting (may not be used): T - pipe mounting, U - universal swivel mounting;
- └ «X6» – type of quantity of cable glands (Metric ISO 965-1 and ISO 965-3: M12=M32x1,5; British Standard Pipe Parallel Thread ISO R228: 1/16" \pm 1"G; National Standard Taper Pipe Thread ANSI/ASME B1.20.1: 1/16" \pm 1"NPT);
- └ «X7» – options, accessories and versions.

OVERALL DIMENSIONS OF FLOOR-STANDING PORTABLE LIGHT FIXTURES

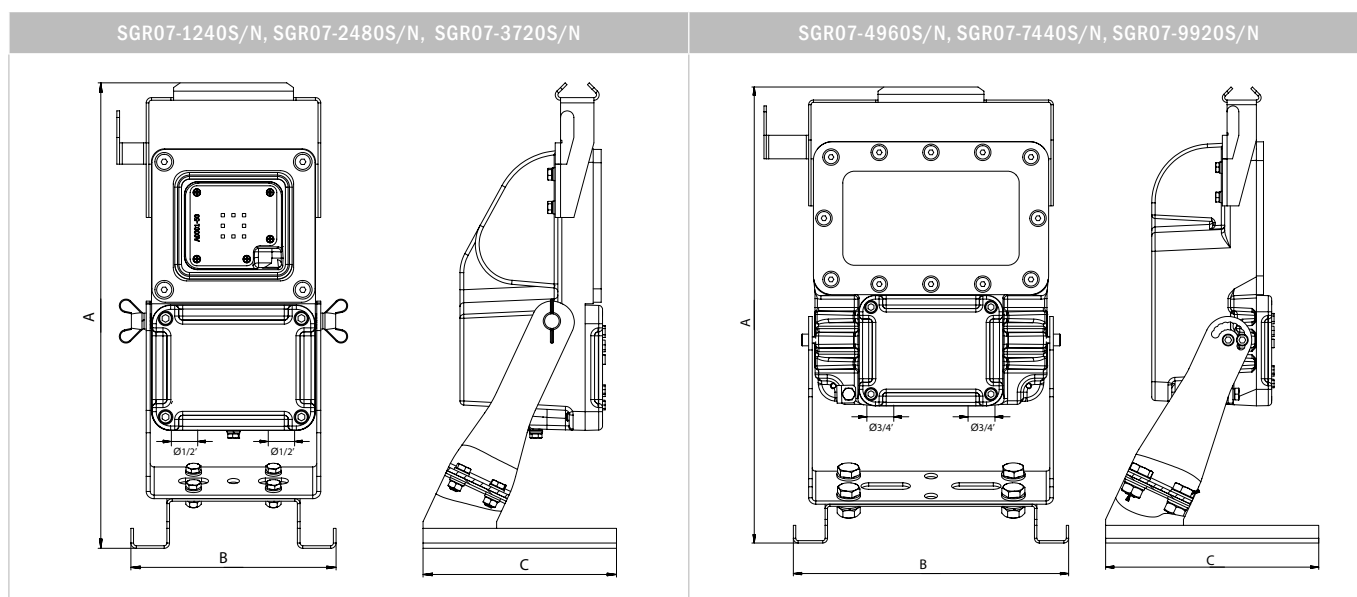

OVERALL DIMENSIONS OF ENCLOSURES

Enclosure type	Size*, mm		
	A	B	C
VSP4-1	349	173	145
VSP4-2	388	259	181

*Permissible deviations in sizes: ± 15 mm

TECHNICAL CHARACTERISTICS OF SGR07 LIGHT FIXTURES

Model	Maximum luminous flux of the light source, lm	Installed power Pinst, W	Temperature class	Recommended type of enclosure
SGR07-1240S-220AC	1240	9,6	T6	VSP4-1
SGR07-1240S-12DC	1240	9,6	T6	VSP4-1
SGR07-2480S-220AC	2480	18,5	T6	VSP4-1
SGR07-2480S-12DC	2480	18,5	T6	VSP4-1
SGR07-3720S-220AC	3720	28,5	T6	VSP4-1
SGR07-3720S-12DC	3720	28,5	T6	VSP4-1
SGR07-4960S-220AC	4960	37	T6	VSP4-2
SGR07-4960S-12DC	4960	37	T6	VSP4-2
SGR07-7440S-220AC	7440	59	T6, T5	VSP4-2
SGR07-7440S-12DC	7440	59	T6, T5	VSP4-2
SGR07-9920S-220AC	9920	71	T6, T5	VSP4-2
SGR07-9920S-12DC	9920	71	T6, T5	VSP4-2



Cable glands available on page 124

FORMATION OF MARKING

SGR07 – X2X3 – X4/X5 – X6/X7 , where

- └ «SGR07» – light fixtures;
- └ «X2» – maximum luminous flux of the installed LED matrix, lm:
SGR07: 1240, 2480, 3720, 4960, 7440, 9920;
- └ «X3» – type of the light source: S – LED matrix;
- └ «X4» – supply voltage designation: 12DC – 10...36V DC, 220AC - 110...230V AC;
- └ «X5» – type of mounting (may not be used): T - pipe mounting, U - universal swivel mounting, N - portable floor mounting, P - ceiling mounting;
- └ «X6» – type of quantity of cable glands (Metric ISO 965-1 and ISO 965-3: M12÷M32x1,5; British Standard Pipe Parallel Thread ISO R228: 1/16" ÷1"G; National Standard Taper Pipe Thread ANSI/ASME B1.20.1: 1/16" ÷1"NPT);
- └ «X7» – options, accessories and versions.



- New generation of high-efficient super bright LED's with luminous flux ~115 lm per 1 W
- Low pulsation coefficient
- Usage of secondary LED's provide luminous flux angle 20°
- Impact- and heat-resistant glass provides high light transmission and mechanical resistance
- Original design with a radiator provides high heat transfer
- Sealed and air-filled chamber for LED plates prevents exposure of dust, moist, aggressive atmospheres and gases (e.g. hydrogen sulfide), avoiding condensation in case of changes in temperature and humidity

MATERIALS

- Material of light reflecting part – tempered glass.
- Material of enclosure – aluminum alloy.
- Material of sealing ring – silicone.
- Material of sealant – PG-REZBA-F sealant, PG-COMPOUND compound.
- The enclosure has external protective antifriction coating which conforms to the requirement of IEC 60079-0: 2011, EN 60079-1: 2014

CERTIFICATION DATA

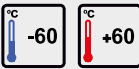
Zones for installation	
Zone 1 - Zone 2 (Gas)	Zone 21 - Zone 22 (Dust)
Version	
IECEX	Ex db eb mb IIC T6...T4 Gb Ex tb IIIC T66°C...111°C Db
ATEX	⊕ II 2 G Ex db eb mb IIC T6...T4 Gb ⊕ II 2 D Ex tb IIIC T66°C ...T111°C Db
 SGP05	
Certification	
IECEX CCVE 18.0012X	All IECEX and ATEX certification data can be downloaded from www.en.exd.ru
EESF 19 ATEX 033X	
Conformance standards	
Light fixture series SGP05... are manufactured in accordance with the requirements of standards and conform to them, IEC 60079-0:2011, IEC 60079-1:2014, IEC 60079-7:2015, IEC 60079-18:2014, IEC 60079-31:2013, EN 60079-0:2012, EN 60079-1:2014, EN 60079-7:2015, EN 60079-18:2014, EN 60079-31:2014 standards.	
Permissible Ambient temperature range	Supply voltage
	10-36DC; 110-230AC

OVERALL DIMENSIONS OF SGP05 FLOODLIGHT WITH PIPE MOUNTING

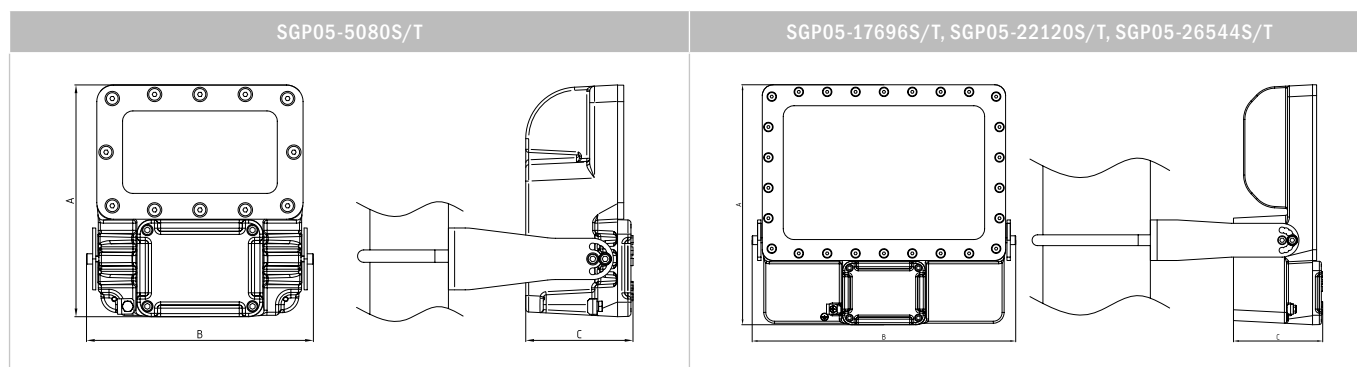

OVERALL DIMENSIONS OF FLOODLIGHT WITH UNIVERSAL MOUNTING

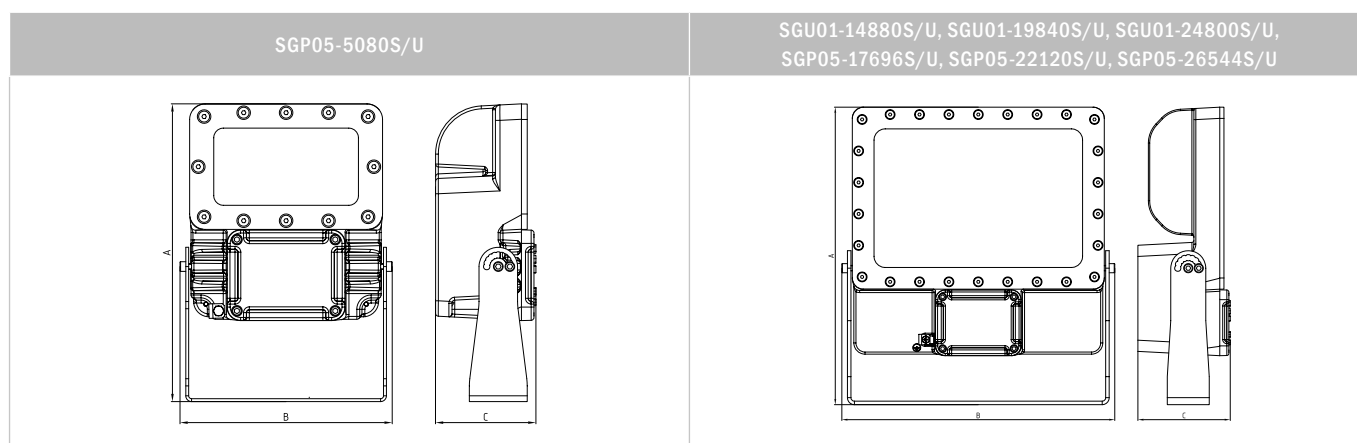

OVERALL DIMENSIONS OF ENCLOSURES

Enclosure type	Type of mounting	Size*, mm		
		A	B	C
VSP4-2	pipe mounting - T	225	226	104
	universal swivel mounting - U	309	220	104
VSP4-3	pipe mounting - T	355	397	132
	universal swivel mounting - U	425	390	132

*Permissible deviations in sizes: ± 15 mm

TECHNICAL CHARACTERISTICS OF SGU01... FLOODLIGHT

Model	Maximum luminous flux of the light source, lm	Installed power Pinst, W	Temperature class	Recommended type of enclosure
SGP05-5080S-12DC	5080	37	T6, T5	VSP4-2
SGP05-5080S-220AC	5080	37	T6, T5	VSP4-2
SGP05-17696S-12DC	17696	134	T6, T5	VSP4-3
SGP05-17696S-220AC	17696	134	T6, T5	VSP4-3
SGP05-22120S-12DC	22120	168	T6, T5, T4	VSP4-3
SGP05-22120S-220AC	22120	168	T6, T5, T4	VSP4-3
SGP05-26544S-12DC	26544	202	T5, T4	VSP4-3
SGP05-26544S-220AC	26544	202	T5, T4	VSP4-3



Cable glands available on page 124

FORMATION OF MARKING

SGP05 – X2X3 – X4/X5 – X6/X7 , where

- └ «SGP05» – floodlight series;
- └ «X2» – maximum luminous flux of the installed LED matrix, lm:
SGP05: 5080, 17696, 22120, 26544;
- └ «X3» – type of the light source: S – LED matrix;
- └ «X4» – supply voltage designation: 12DC – 10...36V DC, 220AC - 110...230V AC;
- └ «X5» – type of mounting (may not be used): T - pipe mounting, U - universal swivel mounting;
- └ «X6» – type of quantity of cable glands (Metric ISO 965-1 and ISO 965-3: M12÷M32x1,5; British Standard Pipe Parallel Thread ISO R228: 1/16" ÷1"G; National Standard Taper Pipe Thread ANSI/ASME B1.20.1: 1/16" ÷1"NPT);
- └ «X7» – options, accessories and versions.



SOUND AND SIGNAL INDICATION

Easy connection

Lower energy consumption

Strong output level

Ergonomic design

TECHNICAL CHARACTERISTICS

Maximum voltage, V	Maximum operating current	Maximum power and type of used lamps
<div style="display: flex; gap: 10px;"> <div style="border: 1px solid black; padding: 2px;">230 AC</div> <div style="border: 1px solid black; padding: 2px;">85 DC</div> </div>	2	14LED

FORMATION OF MARKING

Individual marking plates are applied to the control stations, which contain as minimum:

- product name;
- name of the manufacturer or its registered trademark;
- European conformity mark with certification body number;
- Ex-marking;
- serial number;
- ambient temperature range;
- number(s) of the certificates or a logo of the body;
- electric parameters;

and other functional data required by regulatory and technical documentation, which shall be specified in the marking by the manufacturer.

Structure of designation of PGS-SIGNAL control stations:

PGS-SIGNAL – X2(X3)X4 / X5 – X6 / X7, where

- └ «PGS-SIGNAL» – product name;
- └ «X2» – type of lamp: SC – LED;
- └ «X3» – color of lamp: K – red, ZH – yellow, Z – green, S – blue;
- └ «X4» – lamp's supply voltage:
 - for red and yellow color: «12AC/DC» - /~ 12...85 V;
 - for green and blue color: «24AC/DC» - /~ 24...85 V;
 - for all colors: «220AC/DC» - /~ 85...230 V;
- └ «X5» – type of mounting: T – pipe mounting, P – ceiling mounting;
- └ «X6» – dimension type of cable gland (if any);
- └ «X7» – options, accessories and versions (if any).

STRUCTURAL PARAMETERS OF LIGHT SIGNALING DEVICE PGS-SIGNAL

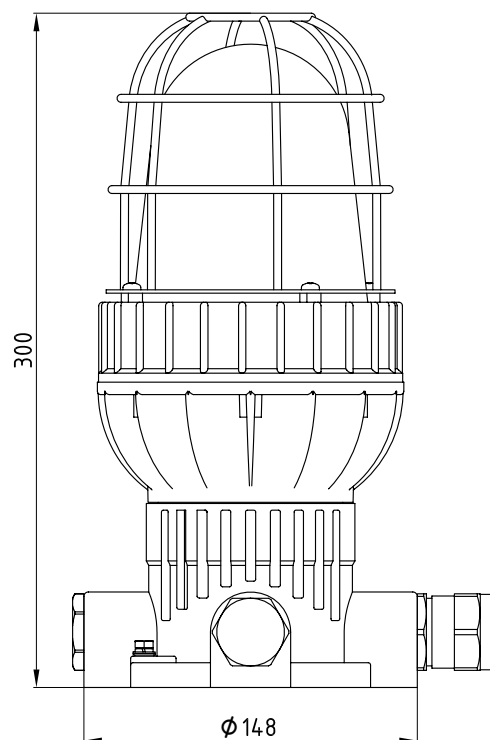

Cable glands available on page 124



- Consists of built-in impulse signal lamp and a heat- impact-resistant borosilicate glass shade installed with threaded joint
- Easy connection: absence of wires between a lamp compartment and an inlet box excludes wire twisting during installation
- Power supply from terminals in the outlet box to the light source comes through the spring-loaded strengthened pins

MATERIALS

- Component parts of enclosure structure of PG... control stations are made from aluminum alloy with magnesium content not more than 1%.
- Fastening bolts of the cover and internal and ex-ternal ground bolts are made for stainless steel.
- Coating of control stations: powder paint.

STRUCTURE AND OPERATION

PGS-VSPYSHKA control stations are used for visual signaling at industrial facilities, at open industrial sites and in other places where presence of explosive substances is possible.

CERTIFICATION DATA

Zones for installation

Zone 1 - Zone 2 (Gas)

Zone 21 - Zone 22 (Dust)

Version

IECEX	Ex db IIC T6 Gb Ex tb IIIC T80°C Db		control stations PGS-VSPYSHKA
ATEX	 II 2 G Ex db IIC T6 Gb  II 2 D Ex tb IIIC T80°C Db		

Certification

IECEX CCVE 19.0005X

All **IECEX** and **ATEX** certification data can be downloaded from www.en.exd.ru

EESF 19 ATEX 035X

Conformance standards

Control stations are manufactured in accordance with standards and conform to them, IEC 60079-0: 2011, IEC 60079-1: 2014, IEC 60079-31: 2013, EN 60079-0: 2012, EN 60079-1: 2014, EN 60079-31: 2014.

Permissible Ambient temperature range

Alternating current frequency, Hz

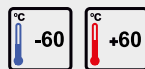

TECHNICAL CHARACTERISTICS

Maximum voltage, V	Maximum operating current	Maximum power and type of used lamps
<div style="display: flex; justify-content: space-around;"> <div style="border: 1px solid black; padding: 2px;">230 AC</div> <div style="border: 1px solid black; padding: 2px;">85 DC</div> </div>	2	14LED , 20Xenon

FORMATION OF MARKING

Individual marking plates are applied to the control stations, which contain as minimum:

- product name;
- name of the manufacturer or its registered trademark;
- European conformity mark with certification body number;
- Ex-marking;
- serial number;
- ambient temperature range;
- number(s) of the certificates or a logo of the body;
- electric parameters;

and other functional data required by regulatory and technical documentation, which shall be specified in the marking by the manufacturer.

Structure of designation of PGS-VSPYSHKA control stations:

PGS-VSPYSHKA – X2(X3)X4 / X5 – X6 / X7, where

- └ «PGS-VSPYSHKA» – product name;
- └ «X2» – type of lamp: K – xenon, SC – LED;
- └ «X3» – color of lamp: K – red, ZH – yellow, Z – green, S – blue, B – white;
- └ «X4» – Isupply voltage: 12DC, 12AC/DC, 24...85DC, 24...85AC/DC, 230AC, 230AC/DC;
- └ «X5» – type of mounting: T – pipe mounting, P – ceiling mounting;
- └ «X6» – dimension type of cable gland (if any);
- └ «X7» – options, accessories and versions (if any).

STRUCTURAL PARAMETERS OF LIGHT SIGNALING DEVICE PGS-VSPYSHKA

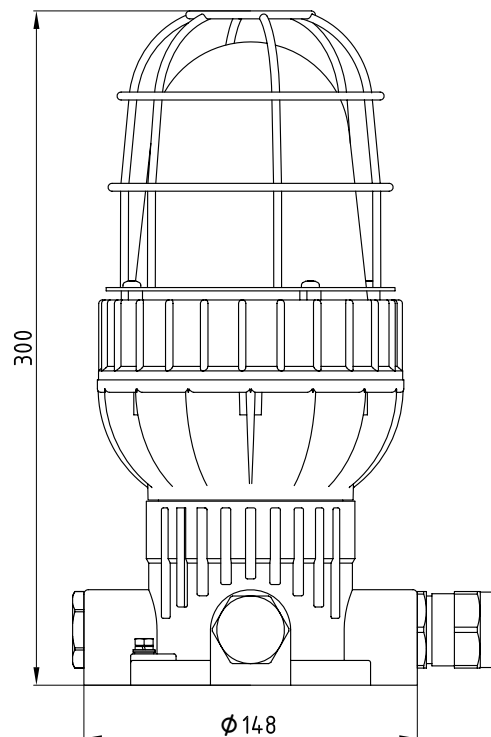

Cable glands available on page 124



- Smaller dimensions, esp. height, in comparison with PGS-IT32 and PGS-IT34
- Window size 320x120 mm ensures high text visibility
- LED illumination provides full sign coverage
- Brightness value 1200 cd/m², consumed power 8 W







MATERIALS

- Component parts of enclosure structure of PG... control stations are made from aluminum alloy with magnesium content not more than 1%.
- Fastening bolts of the cover and internal and ex-ternal ground bolts are made for stainless steel.
- Coating of control stations: powder paint.



STRUCTURE AND OPERATION

PGS-IT35 series control stations are applied as information signs, for visual signaling in hazardous areas.

CERTIFICATION DATA

Zones for installation	
Zone 1 - Zone 2 (Gas)	Zone 21 - Zone 22 (Dust)
Version	
IECEX Ex db IIC T6 Gb Ex tb IIIC T75°C Db	 control stations PGS-IT35
ATEX  II 2 G Ex db IIC T6 Gb  II 2 D Ex tb IIIC T75°C Db	
Certification	
IECEX CCVE 19.0005X	All IECEX and ATEX certification data can be downloaded from www.en.exd.ru
EESF 19 ATEX 035X	
Conformance standards	
Control stations are manufactured in accordance with standards and conform to them, IEC 60079-0: 2011, IEC 60079-1: 2014, IEC 60079-31: 2013, EN 60079-0: 2012, EN 60079-1: 2014, EN 60079-31: 2014.	
Permissible Ambient temperature range	Alternating current frequency, Hz
 -60  +60	 50/60

TECHNICAL CHARACTERISTICS

Maximum voltage, V	Maximum operating current	Maximum power and type of used lamps
 230 AC  36 DC	2	-

FORMATION OF MARKING

Individual marking plates are applied to the control stations, which contain as minimum:

- product name;
- name of the manufacturer or its registered trademark;
- European conformity mark with certification body number;
- Ex-marking;
- serial number;
- ambient temperature range;
- number(s) of the certificates or a logo of the body;
- electric parameters;

and other functional data required by regulatory and technical documentation, which shall be specified in the marking by the manufacturer.

Structure of designation of PGS-IT35 control stations:

PGS-IT35 - X2 - X3 - X4 - X5 / X6, where

- └ «PGS-IT35» – product name;
- └ «X2» – text (or pictogram code);
- └ «X3» – text color: B – white, K – red, ZH – yellow, Z – green, S – blue, CH – black;
- └ «X4» – background color code: B – white, K – red, ZH – yellow, Z – green, S – blue, CH – black;
- └ «X5» – number and type of cable glands (if any);
- └ «X6» – options, accessories and versions (if any).

DESIGN PARAMETERS OF LIGHT SIGN PGS-IT35

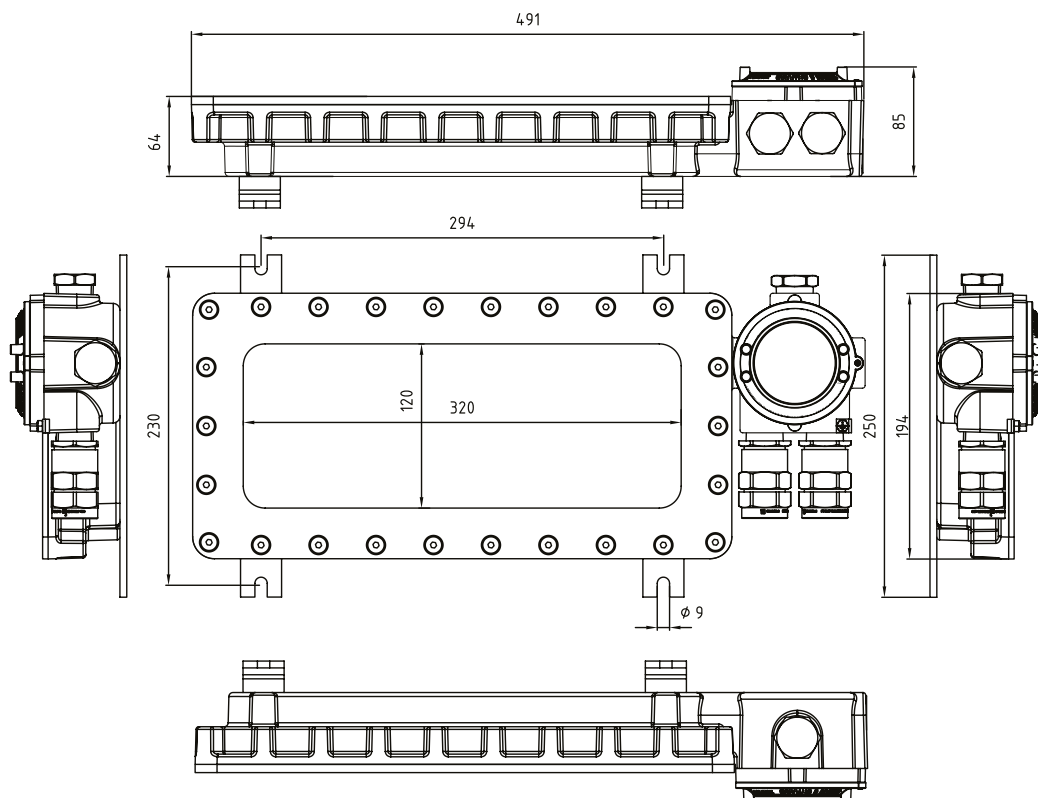

Cable glands available on page 124



- Uninterrupted 24-hour work in a stand-by mode (single alarm tone)
- Maximum acoustic pressure level no less than 114 dB
- Circular pattern of direction

MATERIALS

- Component parts of enclosure structure of PG... control stations are made from aluminum alloy with magnesium content not more than 1%.
- Fastening bolts of the cover and internal and ex-ternal ground bolts are made for stainless steel.
- Coating of control stations: powder paint.

STRUCTURE AND OPERATION

PGZ-SIRENA2 control stations are used for audible signaling in hazardous areas.

CERTIFICATION DATA

Zones for installation

Zone 1 - Zone 2 (Gas)

Zone 21 - Zone 22 (Dust)

Version

IECEX Ex db eb mb IIC T6...T5 Gb
Ex tb IIIC T51°C... T100°C Db



control stations PGZ-SIRENA2

ATEX Ⓜ II 2 G Ex db eb mb IIC T6...T5 Gb
Ⓜ II 2 D Ex tb IIIC T51°C... T100°C Db

Certification

IECEX CCVE 19.0005X

All **IECEX** and **ATEX** certification data can be downloaded from www.en.exd.ru

EESF 19 ATEX 035X

Conformance standards

Control stations are manufactured in accordance with standards and conform to them, IEC 60079-0: 2011, IEC 60079-1: 2014, IEC 60079-7:2015, IEC 60079-18:2014, IEC 60079-31: 2013, EN 60079-0: 2012, EN 60079-1: 2014, EN 60079-7:2015, EN 60079-18:2014, EN 60079-31: 2014.

Permissible Ambient temperature range

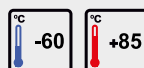

Alternating current frequency, Hz

50/60

TECHNICAL CHARACTERISTICS

Maximum voltage, V	Maximum operating current	Maximum power and type of used lamps
<div style="display: flex; gap: 10px;"> <div style="border: 1px solid black; padding: 2px;">230 AC</div> <div style="border: 1px solid black; padding: 2px;">36 DC</div> </div>	2	-

FORMATION OF MARKING

Individual marking plates are applied to the control stations, which contain as minimum:

- product name;
- name of the manufacturer or its registered trademark;
- European conformity mark with certification body number;
- Ex-marking;
- serial number;
- ambient temperature range;
- number(s) of the certificates or a logo of the body;
- electric parameters;

and other functional data required by regulatory and technical documentation, which shall be specified in the marking by the manufacturer.

Structure of designation of PGZ-SIRENA2 control stations:

PGZ-SIRENA2 - X2 - X3 / X4, where

- └ «PGZ-SIRENA2» - product name;
- └ «X2» - supply voltage: «12DC» - 12 V, «24DC» - 24...36 V, «220AC» - ~230 V;
- └ «X3» - dimension type of cable gland (if any);
- └ «X4» - options, accessories and versions (if any).

STRUCTURAL PARAMETERS OF SIGNALING DEVICES PGZ-SIRENA2

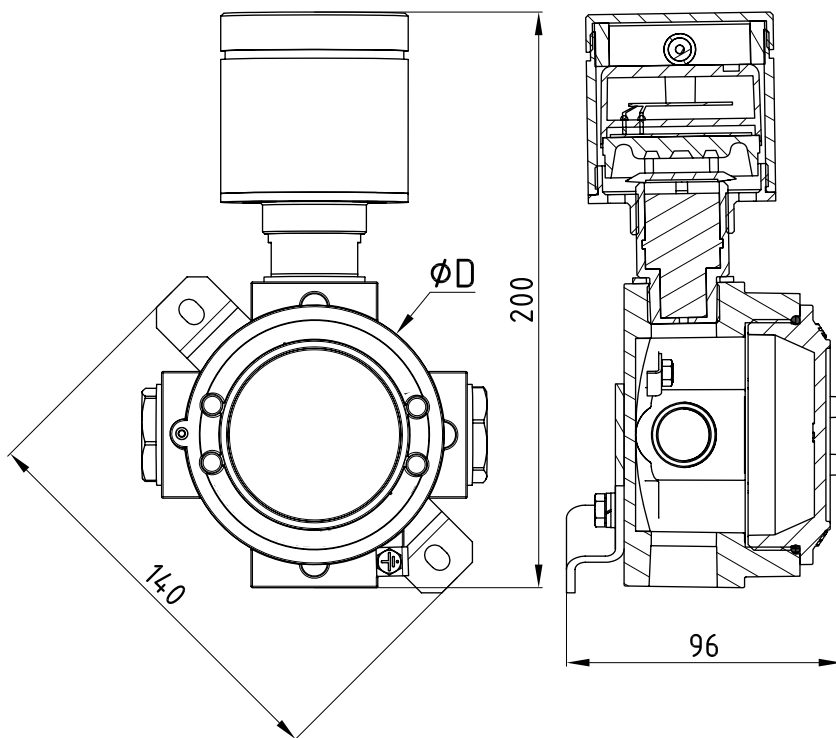

Cable glands available on page 124



- Includes functions of both sound and light signaling devices
- Structural design allows both network connection for collaborative work of the siren and the beacon and a separate connection for standalone work mode
- Strong output level in large and/or noisy areas provides efficient signalization with accurate and strong signal
- Reduces the amount of alarms and cables needed, which makes installation easier
- Easy connection: absence of wires between a lamp compartment and an inlet box excludes wire twisting during installation

MATERIALS

- Component parts of enclosure structure of PG... control stations are made from aluminum alloy with magnesium content not more than 1%.
- Fastening bolts of the cover and internal and ex-ternal ground bolts are made for stainless steel.
- Coating of control stations: powder paint.

STRUCTURE AND OPERATION

PGSK01... local control stations include functions of visual and audible alarm.

CERTIFICATION DATA

Zones for installation

Zone 1 - Zone 2 (Gas) Zone 21 - Zone 22 (Dust)

Version

IECEX	Ex db eb mb IIC T6 Gb Ex tb IIIC T80°C Db		control stations PGSK01...
ATEX	⊕ II 2 G Ex db eb mb IIC T6 Gb ⊕ II 2 D Ex tb IIIC T80°C Db		

Certification

IECEX CCVE 19.0005X All **IECEX** and **ATEX** certification data can be downloaded from www.en.exd.ru
EESF 19 ATEX 035X

Conformance standards

Control stations are manufactured in accordance with standards and conform to them, IEC 60079-0: 2011, IEC 60079-1: 2014, IEC 60079-7:2015, IEC 60079-18:2014, IEC 60079-31: 2013, EN 60079-0: 2012, EN 60079-1: 2014, EN 60079-7:2015, EN 60079-18:2014, EN 60079-31: 2014.

Permissible Ambient temperature range

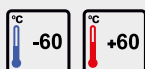

Alternating current frequency, Hz

50/60

TECHNICAL CHARACTERISTICS

Maximum voltage, V	Maximum operating current	Maximum power and type of used lamps
<div style="display: flex; gap: 10px;"> <div style="border: 1px solid black; padding: 2px;">230 AC</div> <div style="border: 1px solid black; padding: 2px;">85 DC</div> </div>	2	14LED, 0,5Xenon

FORMATION OF MARKING

Individual marking plates are applied to the control stations, which contain as minimum:

- product name;
- name of the manufacturer or its registered trademark;
- European conformity mark with certification body number;
- Ex-marking;
- serial number;
- ambient temperature range;
- number(s) of the certificates or a logo of the body;
- electric parameters;

and other functional data required by regulatory and technical documentation, which shall be specified in the marking by the manufacturer.

Structure of designation of PGSK01... control stations:

PGSK01... - X2(X3)X4 / X5 - X6 / X7, where

- └ «PGSK01...» - product name;
- └ «X2» - type of lamp: K - xenon, SC - LED;
- └ «X3» - color of lamp: K - red, ZH - yellow, Z - green, S - blue;
- └ «X4» - lamp's supply voltage:
 - for xenon lamps: «12DC» - 12 V, «24DC» - 24...85 V, «220AC» - ~230 V;
 - for LED lamps: «12AC/DC» - /~ 12/24/85 V, «220AC/DC» - /~ 230 V;
- └ «X5» - type of lighting: P - constant, M - flashing;
- └ «X6» - dimension type of cable gland (if any);
- └ «X7» - options, accessories and versions (if any).

STRUCTURAL PARAMETERS OF PGSK01 LIGHT AND SOUND ALARM

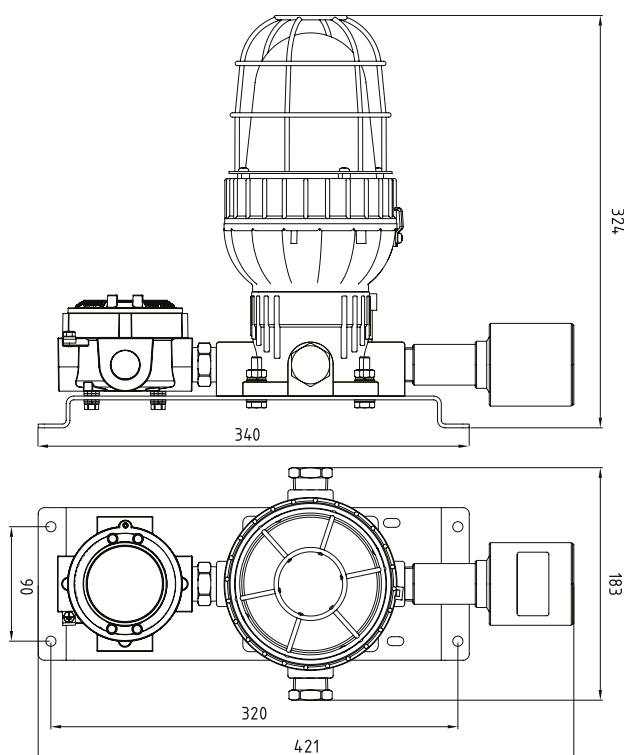

Cable glands available on page 124



- Level of acoustic pressure up to 106 dB
- Strong output level in large and/or noisy areas provides efficient signalization with accurate and strong signal
- Reduces the amount of alarms and cables needed, which makes installation easier
- Supplied with different cable glands

MATERIALS

- Component parts of enclosure structure of PG... control stations are made from aluminum alloy with magnesium content not more than 1%.
- Fastening bolts of the cover and internal and ex-ternal ground bolts are made for stainless steel.
- Coating of control stations: powder paint.

STRUCTURE AND OPERATION

PGSK02... local control stations are intended for sound and visual signaling for indication of modes of operation of process equipment and for drawing attention of people in emergency and other situations.

CERTIFICATION DATA

Zones for installation

Zone 1 - Zone 2 (Gas) Zone 21 - Zone 22 (Dust)

Version

IECEX	Ex db eb mb IIC T6...T5 Gb Ex tb IIIC T51°C... T100°C Db		control stations PGSK02...
ATEX	⊕ II 2 G Ex db eb mb IIC T6...T5 Gb ⊕ II 2 D Ex tb IIIC T51°C...T100°C Db		

Certification

IECEX CCVE 19.0005X	All IECEX and ATEX certification data can be downloaded from www.en.exd.ru
EESF 19 ATEX 035X	

Conformance standards

Control stations are manufactured in accordance with standards and conform to them, IEC 60079-0: 2011, IEC 60079-1: 2014, IEC 60079-7:2015, IEC 60079-18:2014, IEC 60079-31: 2013, EN 60079-0: 2012, EN 60079-1: 2014, EN 60079-7:2015, EN 60079-18:2014, EN 60079-31: 2014.

Permissible Ambient temperature range	Alternating current frequency, Hz
	

TECHNICAL CHARACTERISTICS

Maximum voltage, V	Maximum operating current	Maximum power and type of used lamps
	16	-

FORMATION OF MARKING

Individual marking plates are applied to the control stations, which contain as minimum:

- product name;
- name of the manufacturer or its registered trademark;
- European conformity mark with certification body number;
- Ex-marking;
- serial number;
- ambient temperature range;
- number(s) of the certificates or a logo of the body;
- electric parameters;

and other functional data required by regulatory and technical documentation, which shall be specified in the marking by the manufacturer.

Structure of designation of PGSK02... control stations:

PGSK02... - X2X3 - X2X3 - X4 - X5 - X4 / X6, where

- └ «PGSK02...» - product name;
- └ «X2» - type of control/indication element: L - lamp, K - button;
- └ «X3» - color of control element: K - red, ZH - yellow, Z - green, S - blue, CH - black (for button);
- └ «X4» - supply voltage;
- └ «X5» - type of cable glands (if any);
- └ «X6» - options, accessories and versions (if any).

STRUCTURAL PARAMETERS OF PGSK02 LIGHT AND SOUND SIGNALING DEVICES

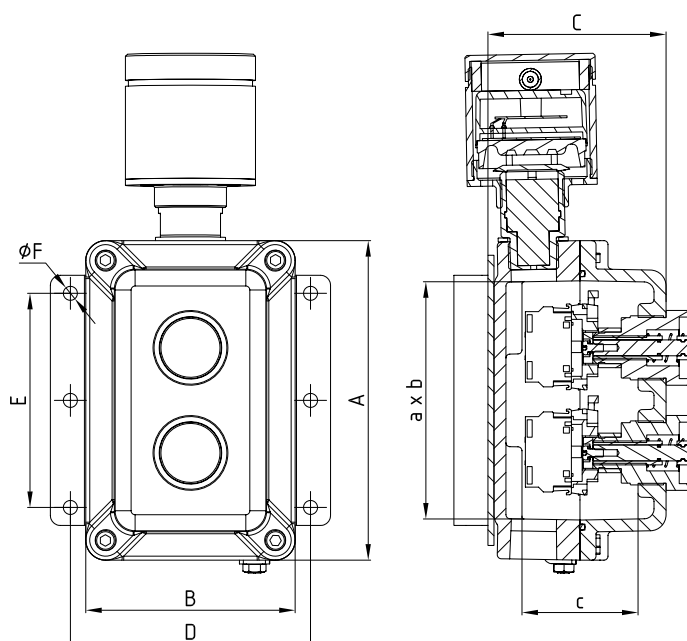

Type of control station	Dimensions, mm								
	Outer			Inner			Fastening		
	A	B	C	a	b	c	D	F	E
PGSK02...	160	105	89	119	64	66	103	8	81.3

Overall dimensions of control stations may change depending on dimension type of the box, installed cable glands and control elements.



Cable glands available on page 124



- Piezo-siren used for generation of sound signals
- Color combinations for light signals selected per customer request
- 8 LEDs of high brightness used as a source of light signals
- Versions with different power supply – 12, 24 V DC and ~220 V AC
- 3 operating modes:
 - Stand-by mode – green indicator is ON, device is switched on and ready for operation
 - Warning mode – intermittent sound and light signalization (duration – 0,5-1s; interval - 0,5-1s);
 - Emergency signalization – constant sound and light signalization

MATERIALS

- Component parts of enclosure structure of PG... control stations are made from aluminum alloy with magnesium content not more than 1%.
- Fastening bolts of the cover and internal and external ground bolts are made for stainless steel.
- Coating of control stations: powder paint.

STRUCTURE AND OPERATION

PGSK03... local control stations are intended for sound and visual signaling for indication of modes of operation of process equipment and for drawing attention of people in emergency and other situations.

CERTIFICATION DATA

Zones for installation

Zone 1 - Zone 2 (Gas)

Zone 21 - Zone 22 (Dust)

Version

IECEX	Ex db eb mb IIC T6 Gb Ex tb IIIC T75°C Db
ATEX	⊕ II 2 G Ex db eb mb IIC T6 Gb ⊕ II 2 D Ex tb IIIC T75°C Db



control stations PGSK03...

Certification

IECEX CCVE 19.0005X

EESF 19 ATEX 035X

All IECEX and ATEX certification data can be downloaded from www.en.exd.ru

Conformance standards

Control stations are manufactured in accordance with standards and conform to them, IEC 60079-0: 2011, IEC 60079-1: 2014, IEC 60079-7:2015, IEC 60079-18:2014, IEC 60079-31: 2013, EN 60079-0: 2012, EN 60079-1: 2014, EN 60079-7:2015, EN 60079-18:2014, EN 60079-31: 2014.

Permissible Ambient temperature range

Alternating current frequency, Hz

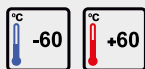

50/60

TECHNICAL CHARACTERISTICS

Maximum voltage, V	Maximum operating current	Maximum power and type of used lamps
<div style="display: flex; gap: 10px;"> <div style="border: 1px solid black; padding: 2px;">230 AC</div> <div style="border: 1px solid black; padding: 2px;">36 DC</div> </div>	2	-

FORMATION OF MARKING

Individual marking plates are applied to the control stations, which contain as minimum:

- product name;
- name of the manufacturer or its registered trademark;
- European conformity mark with certification body number;
- Ex-marking;
- serial number;
- ambient temperature range;
- number(s) of the certificates or a logo of the body;
- electric parameters;

and other functional data required by regulatory and technical documentation, which shall be specified in the marking by the manufacturer.

Structure of designation of PGSK03... control stations:

PGSK03... - X2 - X3 - X4 - X5 / X6, where

- └ «PGSK03...» - product name;
- └ «X2» - color of intermitting mode of operation of light indication: K - red, ZH - yellow, Z - green;
- └ «X3» - color of constant mode of operation of light indication: K - red, ZH - yellow, Z - green;
- └ «X4» - supply voltage;
- └ «X5» - type of cable glands (if any);
- └ «X6» - options, accessories and versions (if any).

STRUCTURAL PARAMETERS OF PGSK03 LIGHT AND SOUND SIGNALING DEVICE

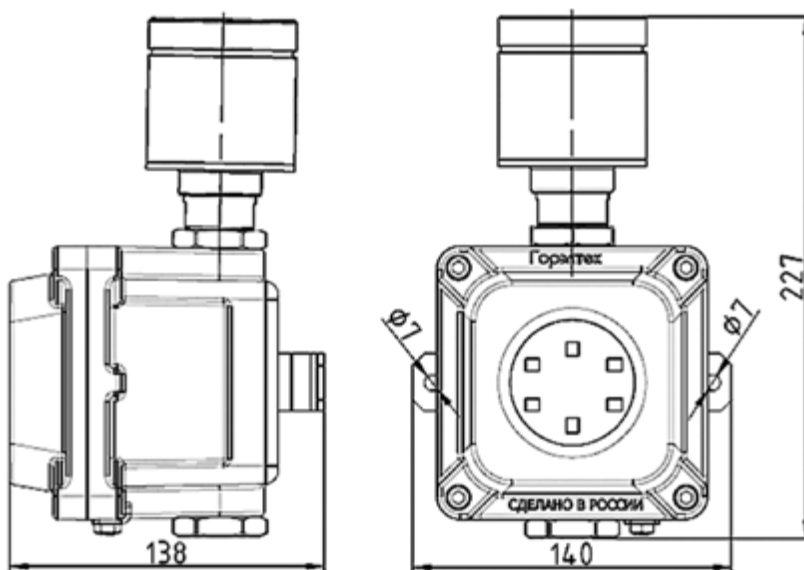

Type of control station	Dimensions, mm								
	Outer			Inner			Fastening		
	A	B	C	a	b	c	D	F	E
PGSK03	119	119	128	77	77	87	-	-	-

Overall dimensions of control stations may change depending on dimension type of the box, installed cable glands and control elements.



Cable glands available on page 124



- LED illumination provides full sign coverage
- Window size 320x120 mm ensures high text visibility
- Ergonomic structural design
- Smaller dimensions, esp. width, allows to place it in storage units, boxes, narrow corridors and above the exits/emergency exits

MATERIALS

- Component parts of enclosure structure of PG... control stations are made from aluminum alloy with magnesium content not more than 1%.
- Fastening bolts of the cover and internal and external ground bolts are made for stainless steel.
- Coating of control stations: powder paint.

STRUCTURE AND OPERATION

PGSK04 series control stations are used as information signs, for visual signaling in hazardous areas.

CERTIFICATION DATA

Zones for installation

Zone 1 - Zone 2 (Gas)

Zone 21 - Zone 22 (Dust)

Version

IECEX	Ex db eb mb IIC T6 Gb Ex tb IIIC T75°C Db
ATEX	⊕ II 2 G Ex db eb mb IIC T6 Gb ⊕ II 2 D Ex tb IIIC T75°C Db



control stations PGSK04...

Certification

IECEX CCVE 19.0005X

All **IECEX** and **ATEX** certification data can be downloaded from www.en.exd.ru

EESF 19 ATEX 035X

Conformance standards

Control stations are manufactured in accordance with standards and conform to them, IEC 60079-0: 2011, IEC 60079-1: 2014, IEC 60079-7:2015, IEC 60079-18:2014, IEC 60079-31: 2013, EN 60079-0: 2012, EN 60079-1: 2014, EN 60079-7:2015, EN 60079-18:2014, EN 60079-31: 2014.

Permissible Ambient temperature range

Alternating current frequency, Hz

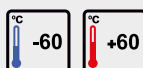

50/60

TECHNICAL CHARACTERISTICS

Maximum voltage, V	Maximum operating current	Maximum power and type of used lamps
<div style="display: flex; gap: 10px;"> <div style="border: 1px solid black; padding: 2px;">230 AC</div> <div style="border: 1px solid black; padding: 2px;">36 DC</div> </div>	2	-

FORMATION OF MARKING

Individual marking plates are applied to the control stations, which contain as minimum:

- product name;
- name of the manufacturer or its registered trademark;
- European conformity mark with certification body number;
- Ex-marking;
- serial number;
- ambient temperature range;
- number(s) of the certificates or a logo of the body;
- electric parameters;

and other functional data required by regulatory and technical documentation, which shall be specified in the marking by the manufacturer.

Structure of designation of PGSK04... control stations:

PGSK04... - X2 - X2X3 - X4 - X5 - X4 / X6, where

- └ «PGSK04...» - product name;
- └ supply voltage;
- └ «X3» - color (or pictogram code);
- └ «X4» - color code: B - white, K - red, ZH - yellow, Z - green, S - blue, CH - black;
- └ «X5» - background color code: B - white, K - red, ZH - yellow, Z - green, S - blue, CH - black;
- └ «X5» - number and type of cable glands (if any);
- └ «X6» - options, accessories and versions (if any).

DESIGN PARAMETERS OF PGSK04 LIGHT AND SOUND SIGNALING DEVICE

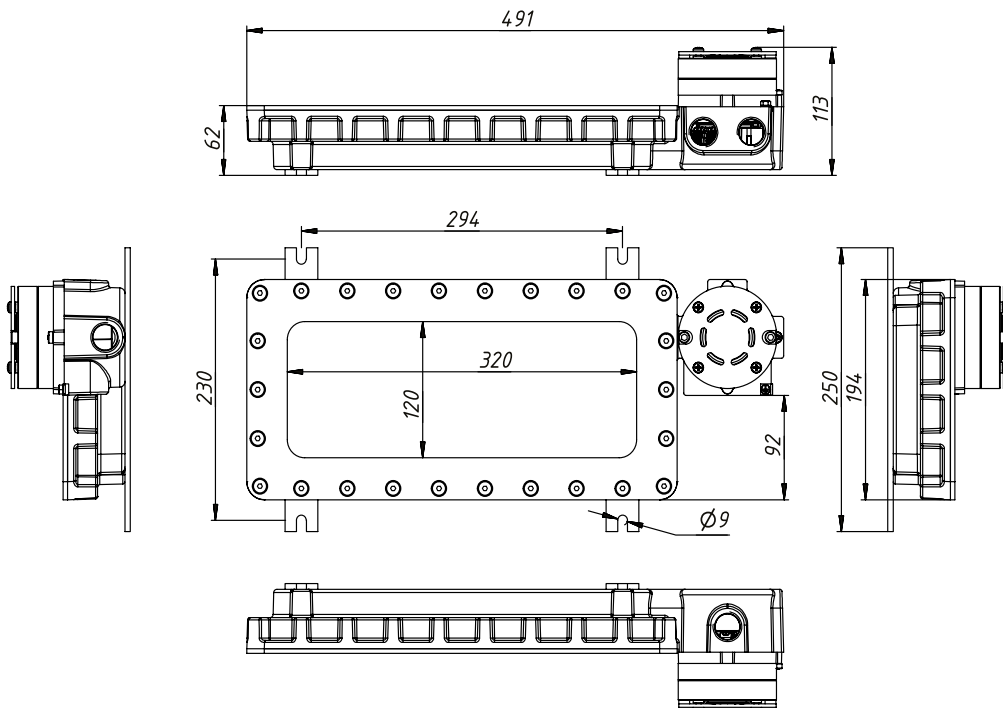

Cable glands available on page 124



- Constant light\twinkling operating modes
- 13 or 25 super bright LED's provide 360 light circumference in horizontal plane
- Various types of mounting available
- Modular explosion-proof light and signaling devices of various configuration and power available upon request
- Light lifespan equals the lifespan of its enclosure which is 25 years

MATERIALS

- The enclosure is made from aluminum alloy.
- Light transmitting cover is made from tempered glass.
- Light transmitting cover can be protected by grid.



CERTIFICATION DATA

Zones for installation

Zone 1 - Zone 2 (Gas)

Zone 21 - Zone 22 (Dust)

Version

IECEX	Ex db IIC T6...T5 Gb Ex tb IIIC T57°C ...T89°C Db		SGA01
ATEX	⊕ II 2 G Ex db IIC T6...T5 Gb ⊕ II 2 D Ex tb IIIC T57°C ...T89°C Db		
IECEX	Ex db IIC T6 Gb Ex tb IIIC T52°C ...T72°C Db		SGA02
ATEX	⊕ II 2 G Ex db IIC T6 Gb ⊕ II 2 D Ex tb IIIC T52°C ...T72°C Db		

Certification

IECEX CCVE 18.0010X

EESF 19 ATEX 014X

All **IECEX** and **ATEX** certification data can be downloaded from www.en.exd.ru

Conformance standards

Light fixture series SG... are manufactured in accordance with Directive 2014/34/EU ATEX standards and conform to them, IEC 60079-0: 2011, IEC 60079-1: 2014, IEC 60079-31: 2013, EN 60079-0: 2012, EN 60079-1: 2014, EN 60079-31: 2014.

Permissible Ambient temperature range

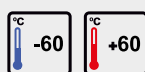

Electric diagram

Direct connection to L, N, PE terminals with cross-section 1,5-4 mm²
Screw terminals I_{max} - 16 A are installed.

OVERALL DIMENSIONS OF THE LIGHT FIXTURE SGA01, SGA02

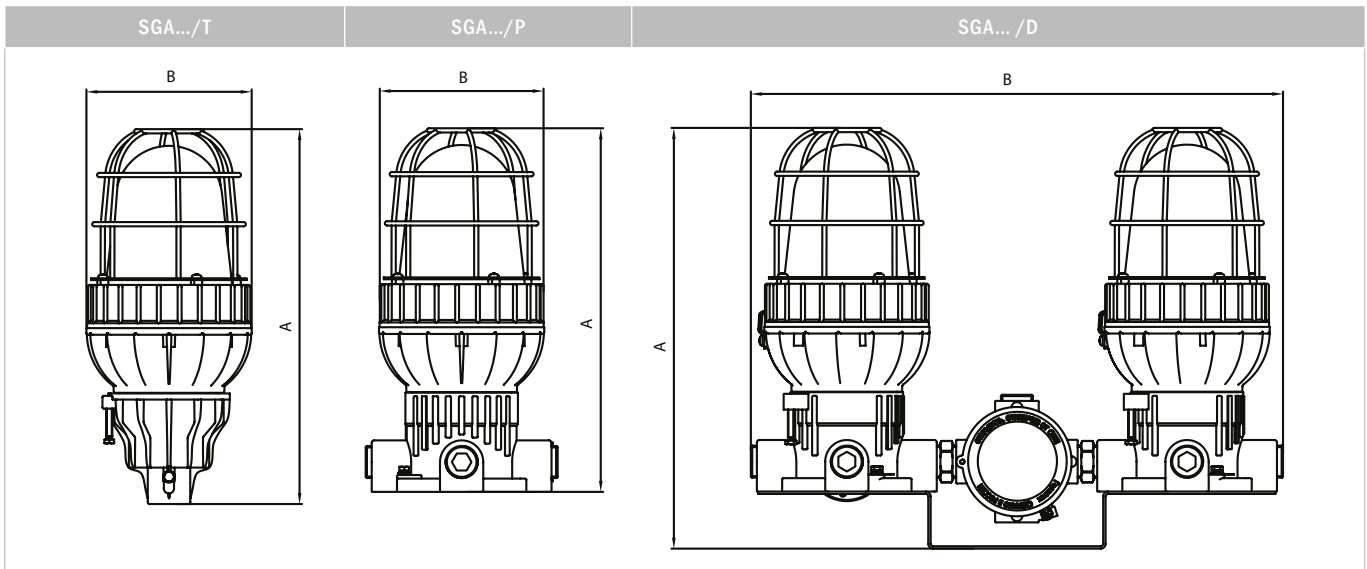

OVERALL DIMENSIONS OF THE LIGHT FIXTURE SGA01, SGA02

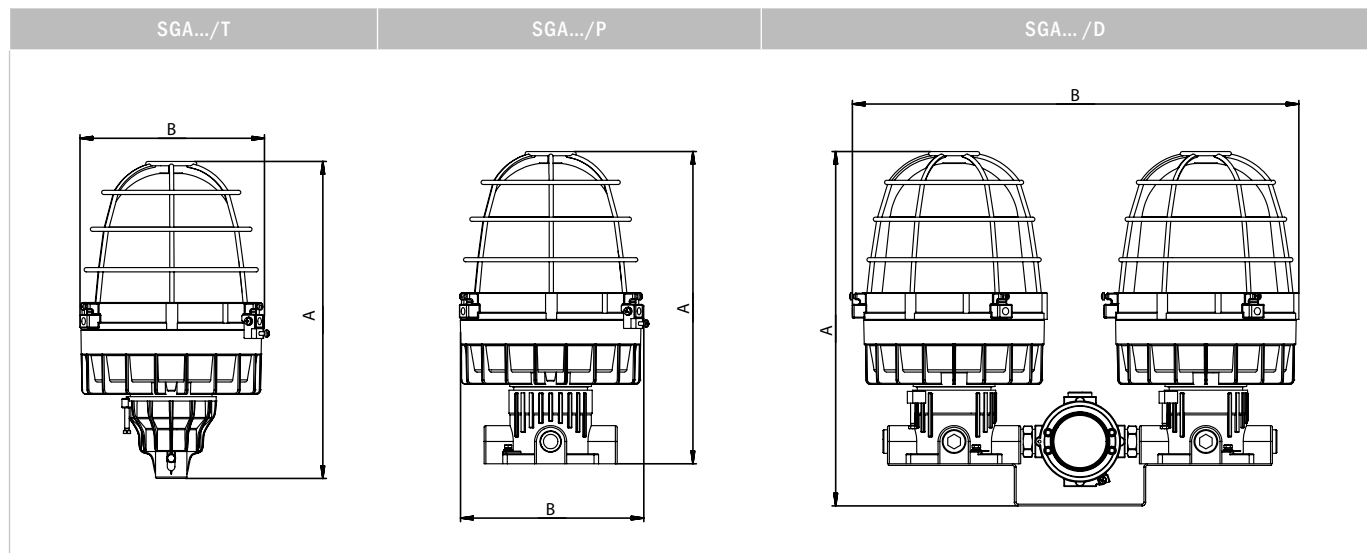

Enclosure type	Type of mounting	Size*, mm	
		A	B
SGJ1.1, SGJ1.2	pipe mounting - T	310	136
SGJ1.1, SGJ1.2	ceiling mounting - P	300	136
SGJ1.1, SGJ1.2	double light fixture - D	347	400

*Limit deviations in sizes: ±15 mm.

TECHNICAL CHARACTERISTICS OF SGA01, SGA02 SERIES LIGHT FIXTURE

Model	Maximum lamp power*, W	Temperature class	Recommended type of enclosure*
SGA01-S	20	T6	SGJ1.1
	40	T6, T5	SGJ1.2
SGA02-SC	14	T6	SGJ1.1

*If required, it can be changed to larger dimension type.



Cable glands available on page 124

FORMATION OF MARKING

SGAX2 – X3 – X4X5/X6 – X7X8/X9, where

- └ «SGA» – light fixture series;
- └ «X2» – type number: 01, 02;
- └ «X3» – type of light source:
 - SGA01: S – LED unit;
 - SGA02: SC – LED lamp;
- └ «X4» – lamp color:
 - SGA01: Red - K; Green - Z;
 - SGA02 Red - K, Yellow - ZH, Green - Z, Blue - S;
- └ «X5» – designation of supply voltage:
 - SGA01: 12DC - 10...36V DC; 220AC - 110...230V AC;
 - SGA02: 12AC/DC - 12...85V; 220AC/DC - 85...230V;
- └ «X6» – type of mounting: pipe mounting - T; ceiling - P; double light fixture - D;
- └ «X7» – SGA01: number of light emitting diodes (if any);
- └ «X8» – illumination type: constant - P; flashing - M (if any);
- └ «X9» – options, accessories and versions.



SOCKETS AND PLUGS

Highly resistant to the exposure of hydrogen sulfide

Lifespan more than 25 years

Self-cleaning calibrated contacts



- Fit portable equipment such as portable lamps, measuring devices, storage batteries, pumps, fans, air blowers, compressors, generators and other portable devices
- RGVK socket fit the enclosures with Ex d protection type as the Ex-component
- RGVK socket switches on by plugging in and turning to 45° VGM plug, which closes internal switch
- Plug can be extracted in OFF position only
- IP66 when socket is placed receptacle down and IP54 in any other position
- RGVK socket can be installed both in enclosure and its cover

MATERIALS

- Enclosure of RG... series sockets are made from aluminum alloy with magnesium content not more than 1%.

CERTIFICATION DATA

Zones for installation

Zone 1 - Zone 2 (Gas)

Zone 21 - Zone 22 (Dust)

Version

IECEX Ex db IIC Gb
Ex tb IIIC Db

ATEX ⚠ II 2 G Ex db IIC Gb
⚠ II 2 D Ex tb IIIC Db



RGVK... series sockets

Certification

IECEX CCVE 18.0016U

EESF 19 ATEX 039U

All **IECEX** and **ATEX** certification data can be downloaded from
www.en.exd.ru

Conformance standards

Plugs and sockets are manufactured in accordance with the requirements of standards and conform to them, IEC 60079-0: 2011, IEC 60079-1: 2014, IEC 60079-31: 2013, EN 60079-0: 2012, EN 60079-1: 2014, EN 60079-31: 2014.

Maximum voltage, V

RGVK-16... 415 AC/DC

RGVK-32... 415 AC/DC

RGVK-63... 690 AC/DC

Maximum current, A

RGVK-16... 16

RGVK-32... 32

RGVK-63... 63

Permissible Ambient temperature range

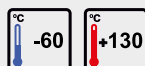

Alternating current frequency, Hz

50/60

FORMATION OF MARKING

Individual marking plates are applied to the control cabinets, which contain as minimum:

- product name;
- name of the manufacturer or its registered trademark;
- European conformity mark with certification body number;
- Ex-marking;
- serial number;
- ambient temperature range;
- number(s) of the certificates or a logo of the body;
- electric parameters;

and other functional data required by regulatory and technical documentation, which shall be specified in the marking by the manufacturer.

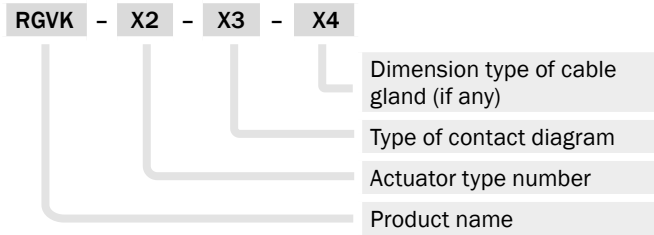

STRUCTURAL PARAMETERS OF RGVK... SOCKETS

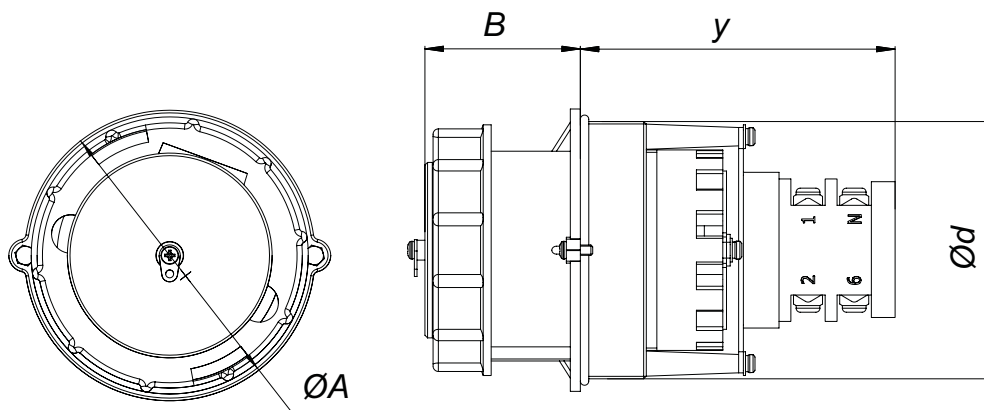

Type	Current, A	Voltage, V	Number of poles	Colors	Dimensions			
					ØA	B	y	Ød - 6g
RGVK-16-24-2	16	12/24	2+T	PURPLE	92	48	110	M84×1,5
RGVK-16-250-2	16	250	2+T	BLUE				
RGVK-16-250-3	16	250	3+T	BLUE				
RGVK-16-415-3	16	415	3+T	RED				
RGVK-16-250-4	16	250	3+N+T	BLUE	107	59	120	M98×1,5
RGVK-16-415-4	16	415	3+N+T	RED				
RGVK-32-250-2	32	250	2+T	BLUE				
RGVK-32-250-3	32	250	3+T	BLUE				
RGVK-32-415-3	32	415	3+T	RED	125	98	152	M110×2
RGVK-32-250-4	32	250	3+N+T	BLUE				
RGVK-32-415-4	32	415	3+N+T	RED				
RGVK-63-250-3	63	250	3+T	BLUE				
RGVK-63-415-3	63	415	3+T	RED	125	98	152	M110×2
RGVK-63-500-3	63	500	3+T	BLACK				
RGVK-63-690-3	63	690	3+T	BLACK				
RGVK-63-415-4	63	415	3+N+T	RED				
RGVK-63-500-4	63	500	3+N+T	BLACK				



- Highly resistant to the exposure of hydrogen sulfide
- Lifespan of flameproof joints is more than 25 years
- RGM sockets are produced with an interlock disconnecter
- Self-cleaning calibrated contacts
- VGM plugs can be connected to common sockets
- RGM sockets fit portable and fixed equipment up to 32 A ampere capacity

MATERIALS

- Enclosure and cover of plugs VG... and sockets RG... are made from aluminum alloy with magne-sium content not more than 1%.
- Fastening bolts of the cover and internal and external grounding bolts are made for stainless steel.
- Coating of plugs and sockets enclosures: powder paint.

CERTIFICATION DATA

Zones for installation

Zone 1 - Zone 2 (Gas)

Zone 21 - Zone 22 (Dust)

Version

IECEX	Ex db IIC T6...T5 Gb Ex tb IIIC T60°C... T95°C Db		VGM-16... series plugs, RGM-16... series sockets
ATEX	 II 2 G Ex db IIC T6...T5 Gb  II 2 D Ex tb IIIC T60°C... T95°C Db		
IECEX	Ex db IIC T6...T5 Gb Ex tb IIIC T60°C... T100°C Db		VGM-32... series plugs, RGM-32... series sockets
ATEX	 II 2 G Ex db IIC T6...T5 Gb  II 2 D Ex tb IIIC T60°C... T100°C Db		

Certification

IECEX CCVE 18.0011X

All **IECEX** and **ATEX** certification data can be downloaded from www.en.exd.ru

EESF 19 ATEX 024X

Conformance standards

Plugs and sockets are manufactured in accordance with the requirements of Directive 2014/34/EU ATEX standards and conform to them, IEC 60079-0: 2011, IEC 60079-1: 2014, IEC 60079-31: 2013, EN 60079-0: 2012, EN 60079-1: 2014, EN 60079-31: 2014.

Maximum voltage, V

RG...-16...VGM-16... 415 AC/DC

Maximum current, A

RG...-16..., VGM-16... 16

RG...-32..., VGM-32... 415 AC/DC

RG...-32..., VGM-32... 32

Permissible Ambient temperature range



Alternating current frequency, Hz

50/60

FORMATION OF MARKING

RGM - X2 - X3 - X4 / X5

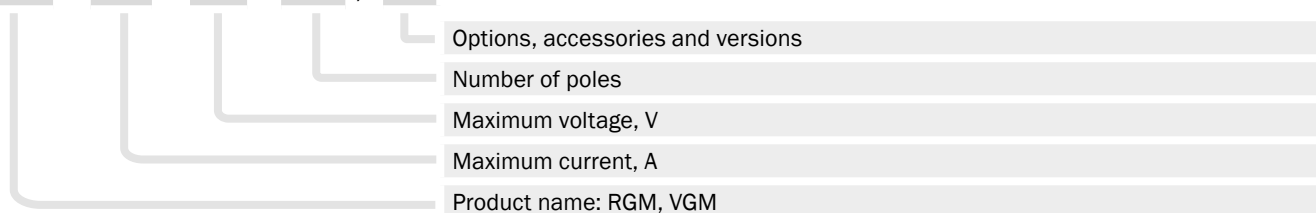

STRUCTURAL PARAMETERS OF RG... SOCKETS

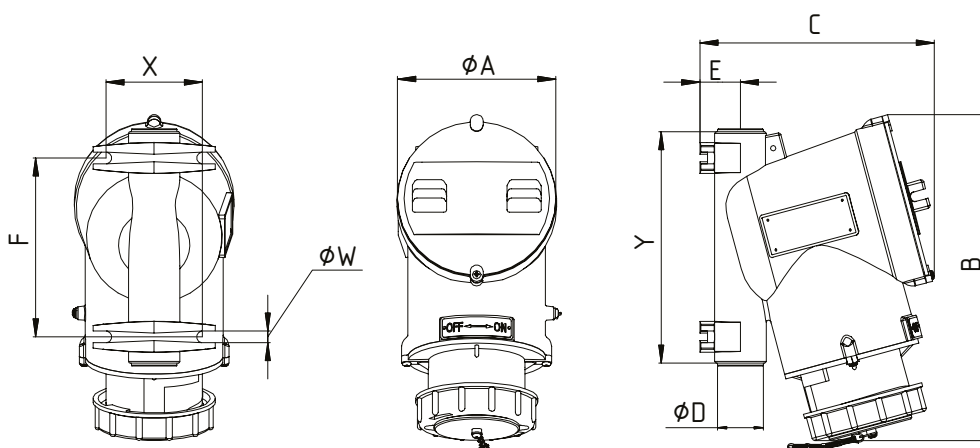

Type	Current, A	Voltage, V	Number of poles	Colors	Dimensions					Mounting dimensions			
					ØA	E	Y	B	C	ØD	X	F	ØW
RGM-16-24-2	16	12/24	2+T	PURPLE	105	24	145	215	155	2 × M25 × 1,5"	65	105	7
RGM-16-250-2	16	250	2+T	BLUE									
RGM-16-250-3	16	250	3+T	BLUE									
RGM-16-415-3	16	415	3+T	RED									
RGM-16-250-4	16	250	3+N+T	BLUE									
RGM-16-415-4	16	415	3+N+T	RED	125	31	180	254	182	2 × M32 × 1,5"	75	140	9
RGM-32-250-2	32	250	2+T	BLUE									
RGM-32-250-3	32	250	3+T	BLUE									
RGM-32-415-3	32	415	3+T	RED									
RGM-32-250-4	32	250	3+N+T	BLUE									
RGM-32-415-4	32	415	3+N+T	RED									

STRUCTURAL PARAMETERS OF VG... PLUGS

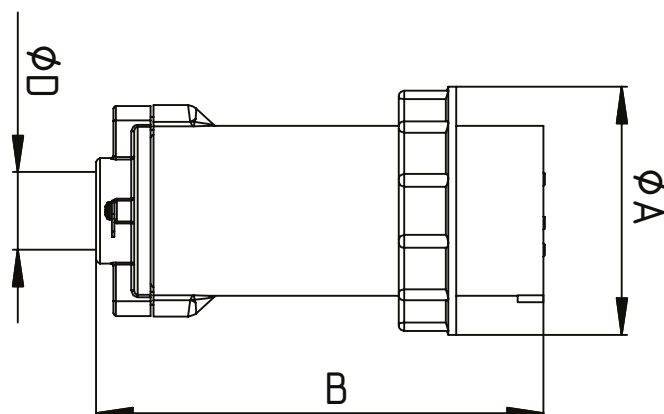

Type	Current, A	Voltage, V	Number of poles	Colors	Dimensions		
					ϕA	B	ϕD
VGM-16-24-2	16	12/24	2+T	PURPLE	80	151,5	M25 × 1,5 "
VGM-16-250-2	16	250	2+T	BLUE			
VGM-16-250-3	16	250	3+T	BLUE			
VGM-16-415-3	16	415	3+T	RED			
VGM-16-250-4	16	250	3+N+T	BLUE			
VGM-16-415-4	16	415	3+N+T	RED	95	171,5	M32 × 1,5 "
VGM-32-250-2	32	250	2+T	BLUE			
VGM-32-250-3	32	250	3+T	BLUE			
VGM-32-415-3	32	415	3+T	RED			
VGM-32-250-4	32	250	3+N+T	BLUE			
VGM-32-415-4	32	415	3+N+T	RED			



Cable glands available on page 124







- Highly resistant to the exposure of hydrogen sulfide
- Lifespan of flameproof joints is more than 25 years
- Fit portable equipment such as portable lamps, measuring devices, storage batteries, pumps, fans, air blowers, compressors, generators and other portable devices
- RGS sockets are produced with an interlock disconnect
- Self-cleaning calibrated contacts
- RGS sockets fit portable and fixed equipment with a capacity 63 A

MATERIALS

- Enclosure and cover of plugs VG... and sockets RG... are made from aluminum alloy with magne-sium content not more than 1%.
- Fastening bolts of the cover and internal and external grounding bolts are made for stainless steel.
- Coating of plugs and sockets enclosures: powder paint.

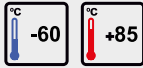
CERTIFICATION DATA

Zones for installation			
Zone 1 - Zone 2 (Gas)		Zone 21 - Zone 22 (Dust)	
Version			
IECEX	Ex db IIC T6...T5 Gb Ex tb IIIC T60°C... T100°C Db		VGS... series plugs, RGS... series sockets
ATEX	 II 2 G Ex db IIC T6...T5 Gb  II 2 D Ex tb IIIC T60°C... T100°C Db		
Certification			
IECEX CCVE 18.0011X		All IECEX and ATEX certification data can be downloaded from www.en.exd.ru	
EESF 19 ATEX 024X			
Conformance standards			
Plugs and sockets are manufactured in accordance with the requirements of Directive 2014/34/EU ATEX standards and conform to them, IEC 60079-0: 2011, IEC 60079-1: 2014, IEC 60079-31: 2013, EN 60079-0: 2012, EN 60079-1: 2014, EN 60079-31: 2014.			
Maximum voltage, V		Maximum current, A	
RGS..., VGS...	690 AC/DC	RGS..., VGS...	63
Permissible Ambient temperature range		Alternating current frequency, Hz	
			

FORMATION OF MARKING

RGS - X2 - X3 - X4 / X5

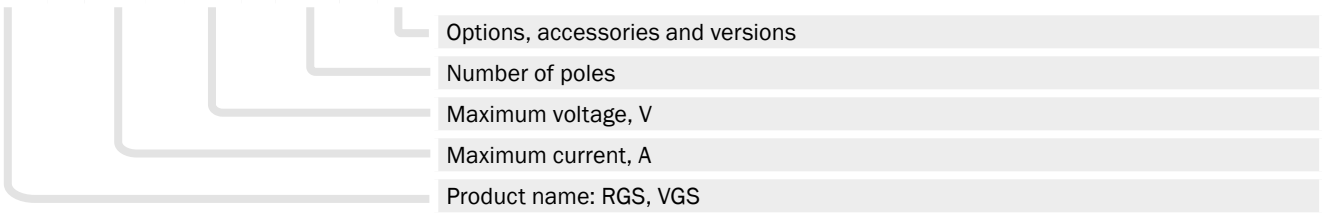

STRUCTURAL PARAMETERS OF RG... SOCKET

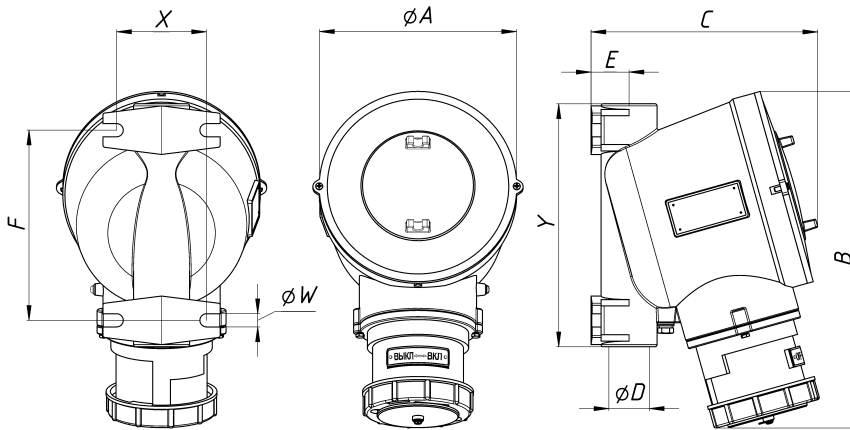

Type	Current, A	Voltage, V	Number of poles	Colors	Dimensions					Mounting dimensions			
					ØA	E	Y	B	C	ØD	X	F	ØW
RGS-63-250-3	63	250	3+T	BLUE	187	36	230	330	215	2 × M40 × 1,5"	85	180	13
RGS-63-415-3	63	145	3+T	RED									
RGS-63-500-3	63	500	3+T	BLUE									
RGS-63-690-3	63	690	3+T	BLACK									
RGS-63-415-4	63	415	3+N+T	BLACK									
RGS-63-500-4	63	500	3+N+T	RED									

STRUCTURAL PARAMETERS OF VG... PLUGS

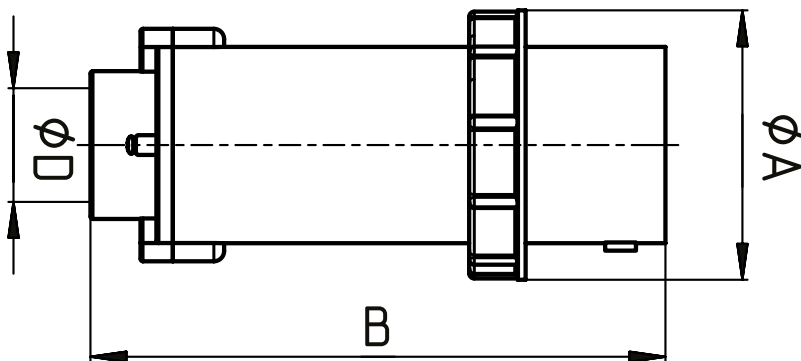

Type	Current, A	Voltage, V	Number of poles	Colors	Dimensions		
					ØA	B	ØD
VGS-63-250-3	63	250	3+T	BLUE	106	242	M50 × 1,5"
VGS-63-415-3	63	145	3+T	RED			
VGS-63-500-3	63	500	3+T	BLACK			
VGS-63-690-3	63	690	3+T	BLACK			
VGS-63-415-4	63	415	3+N+T	RED			
VGS-63-500-4	63	500	3+N+T	BLACK			



Cable glands available on page 124



CABLE GLANDS AND ACCESSORIES

Extended lifespan

Ergonomic design

Highly resistant to external impact



- Can be used to direct insert as a part of explosion-proof enclosures IIA, IIB+H2, IIC, which volume exceeds 2000 cm³
- One sealing ring for every diameter safely tightens cable and ensures Exd explosion protection
- Sealing ring allows the gland to withstand the force equal to the twentyfold cable diameter
- Suitable for cables with operating voltage over 3.3 kV
- Can be used with the equipment having Ex nR marking
- Increased wall thickness considerably enhances the strength of cable gland

MATERIALS

- Cable glands can be made from: brass; nickel-plated brass; stainless steel; galvanized steel.
- Sealing ring material – silicone.





CERTIFICATION DATA

Zones for installation

Zone 1 - Zone 2 (Gas)

Zone 21 - Zone 22 (Dust)

Version

IECEX	Ex db IIC Gb Ex eb IIC Gb Ex nR IIC Gc Ex tb IIIC Db		KNV <i>The following marking may not be put on cable glands: Ex eb IIC Gb, Ex nR IIC Gc, Ex tb IIIC Db, but marking shall be given in accompanying documentation.</i>
ATEX	 II 2 G Ex db IIC Gb  II 2 D Ex tb IIIC Db  II 2 G Ex eb IIC Gb  II 3 G Ex nR IIC Gc		

Certification

IECEX CCVE 17.0004X

EESF 19 ATEX 023X

VTT 18 ATEX 013 (dimension types 01-6)

All **IECEX** and **ATEX** certification data can be downloaded from www.en.exd.ru

Conformance standards

Cable glands for non-armored cable are manufactured in accordance with the regulations of IEC 60079-0:2011, IEC 60079-1:2014, IEC 60079-7:2015, IEC 60079-15:2010, IEC 60079-31:2013, GOST R IEC 60079-0-2011, GOST 30852.8-2002, GOST 30852.10-2002 (IEC 60079-11:1999), GOST 30852.14-2002, GOST 30852.20-2002, EN 60079-0:2012, EN 60079-1:2014, EN 60079-7:2015, EN 60079-15:2010, EN 60079-31:2014 standards and conform to them.

Service temperature

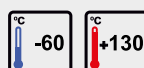

CONSTRUCTION OF CABLE GLAND KNV

DESIGN PARAMETERS OF CABLE GLANDS KNV

1. Body with connecting thread;
2. Internal sealing ring;
3. Bushing;
4. Nut.
5. Internal sealing ring (option P).

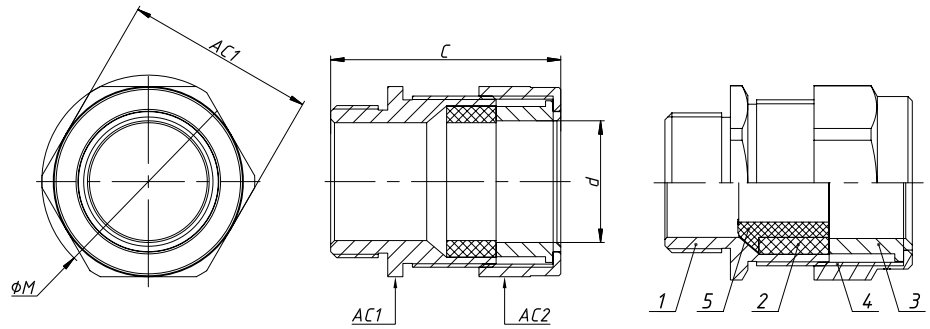

MAIN TECHNICAL DATA OF KNV

Dimension type of enclosure	Thread	Dimensions, mm				Diameter of crimped cable d, mm
		AC1	AC2	ØM	C	
KNV01M	M16x1,5	24	24	26	53	3 - 8
KNV1M	M20x1,5	26	26	28,5	46	6 - 12
KNV2M	M25x1,5	34	34	38	51	12 - 18
KNV2M/P	M25x1,5	34	34	38	51	6 - 18
KNV3M	M32x1,5	40	40	44,5	56,5	18 - 25
KNV3M/P	M32x1,5	40	40	44,5	56,5	12 - 25
KNV4M	M40x1,5	50	50	56	54	25 - 31
KNV5M	M50x1,5	57	60	67	61	31 - 39
KNV6M	M63x1,5	68	70	77	64	39 - 47
KNV7M	M75x1,5	80	75	88	70	47 - 55
KNV71M	M75x1,5	82	78	90	74	55 - 63
KNV8M	M90x1,5	95	90	105	74	63 - 71
KNV81M	M90x1,5	102	98	110	76	71 - 79
KNV10M	M100x1,5	115	110	122	97	79 - 87
KNV101M	M100x1,5	120	115	128	107	84 - 92
KNV01N	3/8" NPT	24	24	26	54	3 - 8
KNV1N	1/2" NPT	26	26	28,5	50	6 - 12
KNV2N	3/4" NPT	34	34	38	54,5	12 - 18
KNV2N/P	3/4" NPT	34	34	38	54,5	6 - 18
KNV3N	1" NPT	40	40	44,5	62,5	18 - 25
KNV3N/P	1" NPT	40	40	44,5	62,5	12 - 25
KNV4N	1 1/4" NPT	50	50	56	60	25 - 31
KNV5N	1 1/2" NPT	57	60	67	69	31 - 39
KNV6N	2" NPT	68	70	77	74	39 - 47
KNV7N	2 1/2" NPT	80	75	88	80	47 - 55
KNV71N	2 1/2" NPT	82	78	90	84	55 - 63
KNV8N	3" NPT	95	90	105	84	63 - 71
KNV81N	3" NPT	102	98	110	86	71 - 79
KNV10N	4" NPT	115	110	122	97	79 - 87
KNV101N	4" NPT	120	115	128	107	84 - 92
KNV01G	3/8" G	24	24	26	54	3 - 8
KNV1G	1/2" G	26	26	28,5	46	6 - 12
KNV2G	3/4" G	34	34	38	51	12 - 18
KNV2G/P	3/4" G	34	34	38	51	6 - 18
KNV3G	1" G	40	40	44,5	62,5	18 - 25
KNV3G/P	1" G	40	40	44,5	62,5	12 - 25
KNV4G	1 1/4" G	50	50	56	60	25 - 31
KNV5G	1 1/2" G	57	60	67	69	31 - 39
KNV6G	2" G	68	70	77	74	39 - 47

Dimension type of enclosure	Thread	Dimensions, mm				Diameter of crimped cable d, mm
		AC1	AC2	ØM	C	
KNV7G	2 1/2" G	80	75	88	80	47 - 55
KNV71G	2 1/2" G	82	78	90	84	55 - 63
KNV8G	3" G	95	90	105	84	63 - 71
KNV81G	3" G	102	98	110	86	71 - 79
KNV10G	4" G	115	110	122	97	79 - 87
KNV101G	4" G	120	115	128	107	84 - 92

INTERNAL SEALING RING FOR KNV (OPTION P)

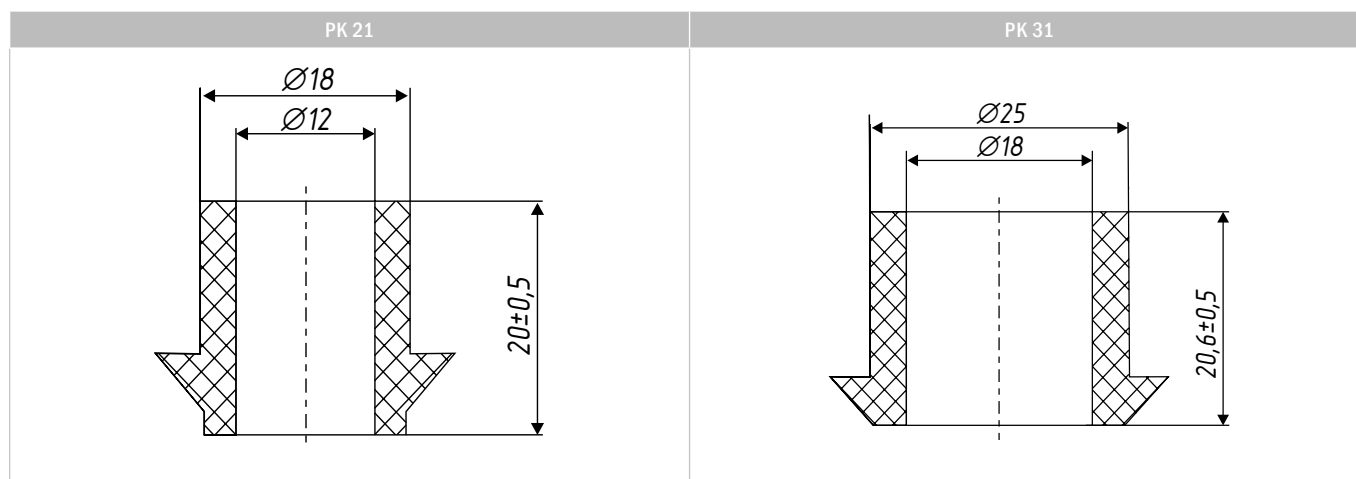

SEALING RINGS APPLIED IN CABLE GLANDS

Type of cable gland	Type of sealing ring	Diameter of crimped cable d, mm
KNV...01	PK 01	3 - 8
KNV...1	PK 1	6 - 12
KNV...2	PK 2	12 - 18
KNV...2.../P	PK 21 / PK 2	6 - 18
KNV...3	PK 3	18 - 25
KNV...3.../P	PK 31 / PK 3	12 - 25
KNV...4	PK 4	25 - 31
KNV...5	PK 5	31 - 39
KNV...6	PK 6	39 - 47
KNV...7	PK 7	47 - 55
KNV...71	PK 71	55 - 63
KNV...8	PK 8	63 - 71
KNV...81	PK 81	71 - 79
KNV...10	PK 10	79 - 87
KNV...101	PK 101	84 - 92

FORMATION OF MARKING

KNV	X1	X2	X3	/	X4
					Options, accessories and versions: 316 - material, stainless steel AISI 316; A31 - ground ring; KG - locknut; UKF - external sealant, external sealing ring - P
					Cable gland material: nickel-plated brass - NK, stainless steel - N, brass - K, galvanized steel - O
					Type of thread: National Standard Taper Pipe Thread - N; metric - M; British Standard Pipe Parallel Thread - G
					Dimension type
					Type of cable gland

**KNVTV**

- Suitable for non-armoured cables in hoses, conduits and metal hoses
- Inner thread on the outlet allows to connect flexible hoses, conduits and corrugated metal hoses
- One sealing ring for every diameter safely tightens cable and ensures Exd explosion protection
- Sealing ring allows the gland to withstand the force equal to the twentyfold cable diameter
- Can be used to direct insert as a part of explosion-proof enclosures IIA, IIB+H2, IIC, which volume exceeds 2000 cm³
- Completely suitable for equipment marked as nR
- Increased wall thickness considerably enhances the strength of cable gland

KNVTN

- Suitable for non-armoured cables in hoses, conduits and metal hoses
- Outer thread allows to connect flexible hoses, conduits and corrugated metal hoses
- One sealing ring for every diameter safely tightens cable and ensures Exd explosion protection
- Sealing ring allows the gland to withstand the force equal to the twentyfold cable diameter
- Can be used to direct insert as a part of explosion-proof enclosures IIA, IIB+H2, IIC, which volume exceeds 2000 cm³
- Completely suitable for equipment marked as nR
- Increased wall thickness considerably enhances the strength of cable gland
- Additional sealing ring can be used to extend the crimped cable diameter range (available for KNVTN2, KNVTN3)

MATERIALS





- Cable glands can be made from: brass; nickel-plated brass; stainless steel; galvanized steel.
- Sealing ring material – silicone.

CERTIFICATION DATA**Zones for installation**

Zone 1 - Zone 2 (Gas)

Zone 21 - Zone 22 (Dust)

Version

IECEX	Ex db IIC Gb Ex eb IIC Gb Ex nR IIC Gc Ex tb IIIC Db		KNVTV, KNVTN <i>The following marking may not be put on cable glands: Ex eb IIC Gb, Ex nR IIC Gc, Ex tb IIIC Db, but marking shall be given in accompanying documentation.</i>
ATEX	 II 2 G Ex db IIC Gb  II 2 D Ex tb IIIC Db  II 2 G Ex eb IIC Gb  II 3 G Ex nR IIC Gc		

Certification

IECEX CCVE 17.0004X

EESF 19 ATEX 023X

VTT 18 ATEX 013 (dimension types 01-6)

All **IECEX** and **ATEX** certification data can be downloaded from www.en.exd.ru

Conformance standards

Cable glands for non-armored cable are manufactured in accordance with the regulations of IEC 60079-0:2011, IEC 60079-1:2014, IEC 60079-7:2015, IEC 60079-15:2010, IEC 60079-31:2013, GOST R IEC 60079-0-2011, GOST 30852.8-2002, GOST 30852.10-2002 (IEC 60079-11:1999), GOST 30852.14-2002, GOST 30852.20-2002, EN 60079-0:2012, EN 60079-1:2014, EN 60079-7:2015, EN 60079-15:2010, EN 60079-31:2014 standards and conform to them.

Service temperature

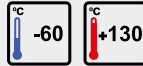

CONSTRUCTION OF CABLE GLAND KNVTV, KNVTN

1. Body with connecting thread;
2. Internal sealing ring;
3. Bushing;
4. Nut;
5. Adapter (not applied for 7 to 81 dimension type of cable gland):
 - KNVTV - internal thread;
 - KNVTN - external thread.
6. Internal sealing ring (option P).

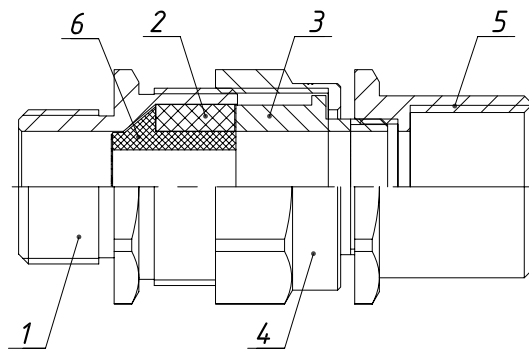

INTERNAL SEALING RING FOR KNVTV, KNVTN (OPTION P)

PK 21	PK 31

DESIGN PARAMETERS OF CABLE GLANDS KNVTV, KNVTN

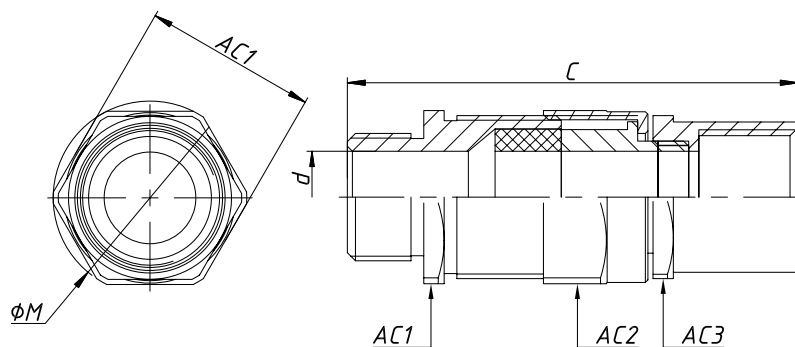

MAIN TECHNICAL DATA OF KNVTV

Dimension type of enclosure	Thread		Dimension sizes*, mm		Diameter of crimped cable d, mm
	M	G, NPT	ØM	C	
01	M16x1,5	3/8"	26	63	3 - 8
1	M20x1,5	1/2"	28,5	77	6 - 12
2	M25x1,5	3/4"	38	84	12 - 18
2.../P	M25x1,5	3/4"	38	84	6 - 18
3	M32x1,5	1"	44,5	97	18 - 25
3.../P	M32x1,5	1"	44,5	97	12 - 25
4	M40x1,5	1 1/4"	56	96	25 - 31
5	M50x1,5	1 1/2"	67	107	31 - 39
6	M63x1,5	2"	77	115	39 - 47
7	M75x1,5	2 1/2"	100	110	47 - 55
71	M75x1,5	2 1/2"	100	110	55 - 63
8	M90x1,5	3"	120	114	63 - 71
81	M90x1,5	3"	120	114	71 - 79

* Information for reference.

MAIN TECHNICAL DATA OF KNVTN

Dimension type of enclosure	Thread		Dimension sizes*, mm		Diameter of crimped cable d, mm
	M	G, NPT	ØM	C	
01	M16x1,5	3/8"	26	70	3 - 8
1	M20x1,5	1/2"	28,5	76	6 - 12
2	M25x1,5	3/4"	38	81	12 - 18
2.../P	M25x1,5	3/4"	38	81	6 - 18
3	M32x1,5	1"	44,5	95	18 - 25
3.../P	M32x1,5	1"	44,5	95	12 - 25
4	M40x1,5	1 1/4"	56	91	25 - 31
5	M50x1,5	1 1/2"	67	104	31 - 39
6	M63x1,5	2"	77	112	39 - 47
7	M75x1,5	2 1/2"	100	120	47 - 55
71	M75x1,5	2 1/2"	100	120	55 - 63
8	M90x1,5	3"	120	124	63 - 71
81	M90x1,5	3"	120	124	71 - 79

* Information for reference.

DIMENSION TYPE OF EXTERNAL THREAD

Dimension type of external thread	Thread	
	M	G, NPT
01	M16x1,5	3/8"
1	M20x1,5	1/2"
2	M25x1,5	3/4"
3	M32x1,5	1"
4	M40x1,5	1 1/4"
5	M50x1,5	1 1/2"
6	M63x1,5	2"
7	M75x1,5	2 1/2"
71	M75x1,5	2 1/2"
8	M90x1,5	3"
81	M90x1,5	3"

SEALING RINGS APPLIED IN CABLE GLANDS

Type of cable gland	Type of sealing ring	Diameter of crimped cable d, mm
KNV...01	PK 01	3 - 8
KNV...1	PK 1	6 - 12
KNV...2	PK 2	12 - 18
KNV...2.../P	PK 21 / PK 2	6 - 18
KNV...3	PK 3	18 - 25
KNV...3.../P	PK 31 / PK 3	12 - 25
KNV...4	PK 4	25 - 31
KNV...5	PK 5	31 - 39
KNV...6	PK 6	39 - 47
KNV...7	PK 7	47 - 55
KNV...71	PK 71	55 - 63
KNV...8	PK 8	63 - 71
KNV...81	PK 81	71 - 79
KNV...10	PK 10	79 - 87
KNV...101	PK 101	84 - 92

FORMATION OF MARKING

KNVTV X1 X2 X3 X4 X5 / X6



Options, accessories and versions: 316 – material, stainless steel AISI 316; A31-ground ring; KG – locknut ; UKF - external sealant; external sealing ring - P

Cable gland material: nickel-plated brass - NK, stainless steel - N, brass - K, galvanized steel - O

Type of thread for thread of external connection**: National Standard Taper Pipe Thread - N; metric - M; British Standard Pipe Parallel Thread - G

Dimension type of external connection*

Type of thread of connection threaded: National Standard Taper Pipe Thread - N; metric - M; British Standard Pipe Parallel Thread - G

Dimension type of connecting thread

Type of cable gland: KNVTN, KNVTV

*Code of dimension type of external thread is not indicated if it coincides with connecting thread.

**Code of type of external thread is not indicated if the type and dimension type of external thread coincide with connecting thread.



- One sealing ring for every diameter safely tightens cable and ensures Exd explosion protection
- Sealing ring allows the gland to withstand the force equal to the twentyfold cable diameter
- Can be used to direct insert as a part of explosion-proof enclosures IIA, IIB+H2, IIC, which volume exceeds 2000 cm³
- Suitable for all types of cable armour/braid: wire armour, braid, tape armour
- Suitable for cables with operating voltage over 3.3 kV
- Increased wall thickness considerably enhances the strength of cable gland

MATERIALS

- Cable glands can be made from: brass; nickel-plated brass; stainless steel; galvanized steel.
- Sealing ring material - silicone.





CERTIFICATION DATA

Zones for installation

Zone 1 - Zone 2 (Gas)

Zone 21 - Zone 22 (Dust)

Version

IECEX	Ex db IIC Gb Ex eb IIC Gb Ex nR IIC Gc Ex tb IIIC Db	 KOV <i>The following marking may not be put on cable glands: Ex eb IIC Gb, Ex nR IIC Gc, Ex db IIC Gb, Ex tb IIIC Db, but marking shall be given in accompanying documentation.</i>
ATEX	 II 2 G Ex db IIC Gb  II 2 D Ex tb IIIC Db  II 2 G Ex eb IIC Gb  II 3 G Ex nR IIC Gc	

Certification

IECEX CCVE 17.0004X	All IECEX and ATEX certification data can be downloaded from www.en.exd.ru
EESF 19 ATEX 023X	
VTT 18 ATEX 013 (dimension types 01-6)	

Conformance standards

Cable glands for armored cable are manufactured in accordance with the regulations of IEC 60079-0:2011, IEC 60079-1:2014, IEC 60079-7:2015, IEC 60079-15:2010, IEC 60079-31:2013, GOST R IEC 60079-0-2011, GOST 30852.8-2002, GOST 30852.10-2002 (IEC 60079-11:1999), GOST 30852.14-2002, GOST 30852.20-2002, EN 60079-0:2012, EN 60079-1:2014, EN 60079-7:2015, EN 60079-15:2010, EN 60079-31:2014 standards and conform to them.

Service temperature

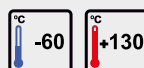

CONSTRUCTION OF CABLE GLAND KOV

1. Body with connecting thread;
2. Internal sealing ring;
3. Taper bushing;
4. Ring for armor fixation;
5. Intermediate body of cable gland;
6. External sealing ring*;
7. Nut.
8. Internal sealing ring (option P).

*Application of external sealing ring in different form is possible.

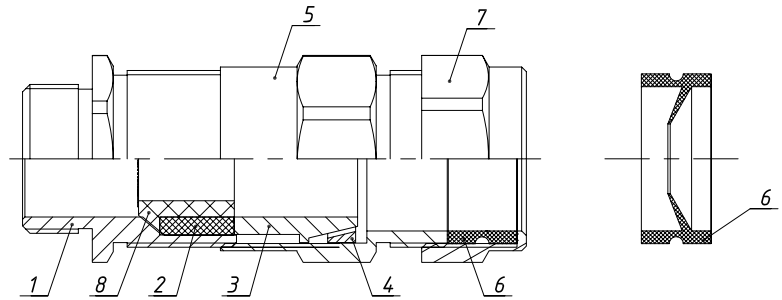

INTERNAL SEALING RING FOR KOV (OPTION P)

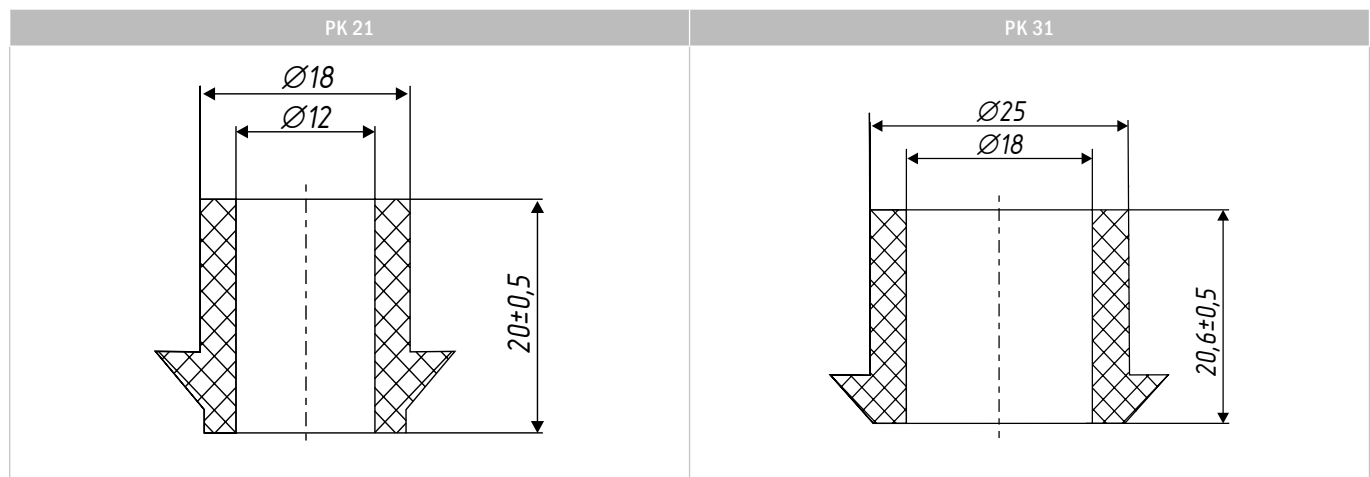

DESIGN PARAMETERS OF CABLE GLANDS KOV

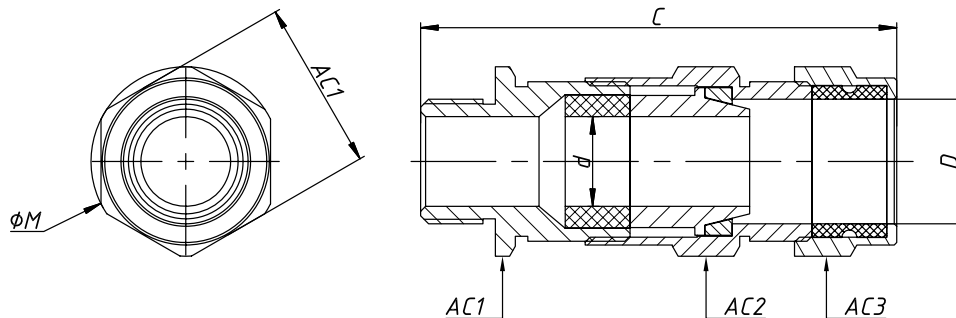

MAIN TECHNICAL DATA OF KOV

Dimension type of enclosure	Thread	Dimensions, mm				Diameter of crimped cable, mm	
		AC1	AC2	ØM	C	d, mm	D, mm
KOV01M	M16x1,5	24	24	26	79	3 - 8	8 - 12
KOV011M	M16x1,5	26	26	28,5	85	6 - 11	9 - 17
KOV1M	M20x1,5	26	26	28,5	83	6 - 12	9 - 17
KOV12M	M20x1,5	34	34	38	95	6 - 12	15 - 25
KOV12M/P	M20x1,5	34	34	38	95	6 - 12	9 - 25
KOV11M	M20x1,5	34	34	38	100	12 - 15	15 - 25
KOV11M/P	M20x1,5	34	34	38	100	3 - 15	9 - 25
KOV2M	M25x1,5	34	34	38	96	12 - 18	15 - 25
KOV2M/P	M25x1,5	34	34	38	96	6 - 18	9 - 25
KOV22M	M25x1,5	40	40	44,5	101	12 - 18	21 - 31
KOV22M/P	M25x1,5	40	40	44,5	101	6 - 18	15 - 31

Dimension type of enclosure	Thread	Dimensions, mm				Diameter of crimped cable, mm	
		AC1	AC2	ØM	C	d, mm	D, mm
KOV21M	M25x1,5	40	40	44,5	104	18 - 20	21 - 31
KOV21M/P	M25x1,5	40	40	44,5	104	7 - 20	15 - 31
KOV3M	M32x1,5	40	40	44,5	115	18 - 25	21 - 31
KOV3M/P	M32x1,5	40	40	44,5	115	12 - 25	15 - 31
KOV32M	M32x1,5	50	50	56	105	18 - 25	27 - 37
KOV32M/P	M32x1,5	50	50	56	105	12 - 25	27 - 32
KOV31M	M32x1,5	50	50	56	106	25 - 27	27 - 37
KOV4M	M40x1,5	50	50	56	110	25 - 31	27 - 37
KOV42M	M40x1,5	57	60	67	104,5	25 - 31	36 - 46
KOV41M	M40x1,5	57	60	67	109	31 - 34	36 - 46
KOV5M	M50x1,5	57	60	67	119	31 - 39	36 - 46
KOV52M	M50x1,5	68	68	77	115,5	31 - 39	45 - 53
KOV51M	M50x1,5	68	68	77	119	39 - 42	45 - 53
KOV6M	M63x1,5	68	70	77	131	39 - 47	45 - 53
KOV62M	M63x1,5	80	80	88	123	39 - 47	52 - 65
KOV61M	M63x1,5	80	80	88	127	47 - 54	52 - 65
KOV7M	M75x1,5	80	80	88	124	47 - 55	52 - 65
KOV71M	M75x1,5	90	92	102	124	55 - 63	65 - 75
KOV8M	M90x1,5	95	97	105	132	63 - 71	71 - 81
KOV81M	M90x1,5	102	108	118	132	71 - 79	81 - 91
KOV01N	3/8" NPT	24	24	26	80	3 - 8	8 - 12
KOV011N	3/8" NPT	26	26	28,5	86	6 - 11	9 - 17
KOV1N	1/2" NPT	26	26	28,5	85	6 - 12	9 - 17
KOV12N	1/2" NPT	34	34	38	97,5	6 - 12	15 - 25
KOV12N/P	1/2" NPT	34	34	38	97,5	6 - 12	9 - 25
KOV11N	1/2" NPT	34	34	38	102	12 - 15	15 - 25
KOV11N/P	1/2" NPT	34	34	38	102	3 - 15	9 - 25
KOV2N	3/4" NPT	34	34	38	98	12 - 18	15 - 25
KOV2N/P	3/4" NPT	34	34	38	98	6 - 18	9 - 25
KOV22N	3/4" NPT	40	40	44,5	103,5	12 - 18	21 - 31
KOV22N/P	3/4" NPT	40	40	44,5	103,5	6 - 18	15 - 31
KOV21N	3/4" NPT	40	40	44,5	107	18 - 20	21 - 31
KOV21N/P	3/4" NPT	40	40	44,5	107	7 - 20	15 - 31
KOV3N	1" NPT	40	40	44,5	115	18 - 25	21 - 31
KOV3N/P	1" NPT	40	40	44,5	115	12 - 25	15 - 31
KOV32N	1" NPT	50	50	56	11,5	18 - 25	27 - 37
KOV32N/P	1" NPT	50	50	56	11,5	12 - 25	27 - 32
KOV31N	1" NPT	50	50	56	112,5	25 - 27	27 - 37
KOV4N	1 1/4" NPT	50	50	56	110	25 - 31	27 - 37
KOV42N	1 1/4" NPT	57	60	67	111	25 - 31	36 - 46
KOV41N	1 1/4" NPT	57	60	67	116	31 - 34	36 - 46
KOV5N	1 1/2" NPT	57	60	67	119	31 - 39	36 - 46
KOV52N	1 1/2" NPT	68	70	77	123	31 - 39	45 - 53
KOV51N	1 1/2" NPT	68	70	77	126,5	39 - 42	45 - 53
KOV6N	2" NPT	68	70	77	113	39 - 47	45 - 53
KOV62N	2" NPT	80	80	88	132,5	39 - 47	52 - 65
KOV61N	2" NPT	80	80	88	136	47 - 54	52 - 65
KOV7N	2 1/2" NPT	80	80	88	134	47 - 55	52 - 65
KOV71N	2 1/2" NPT	90	92	102	134	55 - 63	65 - 75
KOV8N	3" NPT	95	97	105	142	63 - 71	71 - 81
KOV81N	3" NPT	102	108	118	142	71 - 79	81 - 91
KOV01G	3/8" G	24	24	26	80	3 - 8	8 - 12
KOV011G	3/8" G	26	26	28,5	-	6 - 11	9 - 17
KOV1G	1/2" G	26	26	28,5	83	6 - 12	9 - 17

Dimension type of enclosure	Thread	Dimensions, mm				Diameter of crimped cable, mm	
		AC1	AC2	ØM	C	d, mm	D, mm
KOV12G	1/2" G	34	34	38	-	6 - 12	15 - 25
KOV12G/P	1/2" G	34	34	38	-	6 - 12	9 - 25
KOV11G	1/2" G	34	34	38	-	12 - 15	15 - 25
KOV11G/P	1/2" G	34	34	38	-	3 - 15	9 - 25
KOV2G	3/4" G	34	34	38	96	12 - 18	15 - 25
KOV2G/P	3/4" G	34	34	38	96	6 - 18	9 - 25
KOV22G	3/4" G	40	40	44,5	-	12 - 18	21 - 31
KOV22G/P	3/4" G	40	40	44,5	-	6 - 18	15 - 31
KOV21G	3/4" G	40	40	44,5	-	18 - 20	21 - 31
KOV21G/P	3/4" G	40	40	44,5	-	7 - 20	15 - 31
KOV3G	1" G	40	40	44,5	115	18 - 25	21 - 31
KOV3G/P	1" G	40	40	44,5	115	12 - 25	15 - 31
KOV32G	1" G	50	50	56	-	18 - 25	27 - 37
KOV32G/P	1" G	50	50	56	-	12 - 25	27 - 32
KOV31G	1" G	50	50	56	-	25 - 27	27 - 37
KOV4G	1 1/4" G	50	50	56	110	25 - 31	27 - 37
KOV42G	1 1/4" G	57	60	67	-	25 - 31	36 - 46
KOV41G	1 1/4" G	57	60	67	-	31 - 34	36 - 46
KOV5G	1 1/2" G	57	60	67	119	31 - 39	36 - 46
KOV52G	1 1/2" G	68	70	77	-	31 - 39	45 - 53
KOV51G	1 1/2" G	68	70	77	-	39 - 42	45 - 53
KOV6G	2" G	68	70	77	131	39 - 47	45 - 53
KOV62G	2" G	80	80	88	-	39 - 47	52 - 65
KOV61G	2" G	80	80	88	-	47 - 54	52 - 65
KOV7G	2 1/2" G	80	80	88	-	47 - 55	52 - 65
KOV71G	2 1/2" G	90	92	102	-	55 - 63	65 - 75
KOV8G	3" G	95	97	105	-	63 - 71	71 - 81
KOV81G	3" G	102	108	118	-	71 - 79	81 - 91

DIMENSION TYPE OF EXTERNAL THREAD

Dimension type of external thread	Thread	
	M	G, NPT
01	M16x1,5	3/8"
1	M20x1,5	1/2"
2	M25x1,5	3/4"
3	M32x1,5	1"
4	M40x1,5	1 1/4"
5	M50x1,5	1 1/2"
6	M63x1,5	2"
7	M75x1,5	2 1/2"
71	M75x1,5	2 1/2"
8	M90x1,5	3"
81	M90x1,5	3"

SEALING RINGS APPLIED IN CABLE GLANDS

Type of cable gland	Type of sealing ring	Diameter of crimped cable d, mm
KOV...01	PK 01	3 - 8
KOV...011	PK 1	6 - 11
KOV...1	PK 1	6 - 12
KOV...12	PK 1	6 - 12
KOV...12.../P	PK 1	6 - 12
KOV...11	PK 2	12 - 15
KOV...11.../P	PK 21 / PK 2	3 - 15
KOV...2	PK 2	12 - 18
KOV...2.../P	PK 21 / PK 2	6 - 18
KOV...22	PK 2	12 - 18
KOV...22.../P	PK 21 / PK 2	6 - 18
KOV...21	PK 3	18 - 20
KOV...21.../P	PK 31 / PK 3	7 - 20
KOV...3	PK 3	18 - 25
KOV...3.../P	PK 31 / PK 3	12 - 25
KOV...32	PK 3	18 - 25
KOV...32.../P	PK 31 / PK 3	12 - 25
KOV...31	PK 4	25 - 27
KOV...4	PK 4	25 - 31
KOV...42	PK 4	25 - 31
KOV...41	PK 5	31 - 34
KOV...5	PK 5	31 - 39
KOV...52	PK 5	31 - 39
KOV...51	PK 6	39 - 42
KOV...6	PK 6	39 - 47
KOV...7	PK 7	47 - 55
KOV...71	PK 71	55 - 63
KOV...8	PK 8	63 - 71
KOV...81	PK 81	71 - 79

FORMATION OF MARKING

KOV	X1	X2	X3	/	X4	
						Options, accessories and versions: 316 - material, stainless steel AISI 316; A31 - ground ring; KG - locknut; UKF - external sealant, external sealing ring - P
						Cable gland material: nickel-plated brass - NK, stainless steel - N, brass - K, galvanized steel - O
						Type of thread: National Standard Taper Pipe Thread - N; metric - M; British Standard Pipe Parallel Thread - G
						Dimension type
						Type of cable gland



- KOVTV cable gland has inner thread on the outlet
- KOVTN cable gland has outer thread on the outlet
- Sealing ring allows the gland to withstand the force equal to the twentyfold cable diameter
- One sealing ring for every diameter safely tightens cable and ensures Exd explosion protection
- The cable gland may be used for all types of cable armour/braid
- Can be used to direct insert as a part of explosion-proof enclosures IIA, IIB+H2, IIC, which volume exceeds 2000 cm³
- Completely suitable for equipment marked as nR
- Increased wall thickness considerably enhances the strength of cable gland

MATERIALS

- Cable glands can be made from: brass; nickel-plated brass; stainless steel; galvanized steel.
- Sealing ring material – silicone.





CERTIFICATION DATA

Zones for installation

Zone 1 - Zone 2 (Gas)

Zone 21 - Zone 22 (Dust)

Version

IECEX	Ex db IIC Gb Ex eb IIC Gb Ex nR IIC Gc Ex tb IIIC Db		KOVTV, KOVTN <i>The following marking may not be put on cable glands: Ex eb IIC Gb, Ex nR IIC Gc, Ex db IIC Gb, Ex tb IIIC Db, but marking shall be given in accompanying documentation.</i>
ATEX	 II 2 G Ex db IIC Gb  II 2 D Ex tb IIIC Db  II 2 G Ex eb IIC Gb  II 3 G Ex nR IIC Gc		

Certification

IECEX CCVE 17.0004X

EESF 19 ATEX 023X

VTT 18 ATEX 013 (dimension types 01-6)

All **IECEX** and **ATEX** certification data can be downloaded from www.en.exd.ru

Conformance standards

Cable glands for armored cable are manufactured in accordance with the regulations of IEC 60079-0:2011, IEC 60079-1:2014, IEC 60079-7:2015, IEC 60079-15:2010, IEC 60079-31:2013, GOST R IEC 60079-0-2011, GOST 30852.8-2002, GOST 30852.10-2002 (IEC 60079-11:1999), GOST 30852.14-2002, GOST 30852.20-2002, EN 60079-0:2012, EN 60079-1:2014, EN 60079-7:2015, EN 60079-15:2010, EN 60079-31:2014 standards and conform to them.

Service temperature

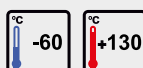

CONSTRUCTION OF CABLE GLAND KOVTV, KOVTN

1. Body with connecting thread;
2. Internal sealing ring (option P);
3. Internal sealing ring;
4. Taper bushing;
5. Ring for armor fixation;
6. Intermediate body of cable gland;
7. External sealing ring*;
8. Nut – adapter;
9. Fluoropolymer ring;
10. Nut;
11. Adapter: KOVTV - internal thread, KOVTN - external thread.

*Sealing rings which are used for IP provision are not responsible for explosion protection of cable gland and due to this may not be marked. Application of external sealing ring in different form is possible

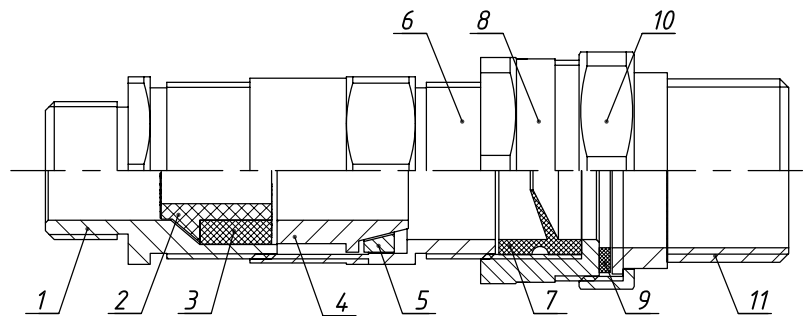

INTERNAL SEALING RING FOR KOVTV, KOVTN (OPTION P)

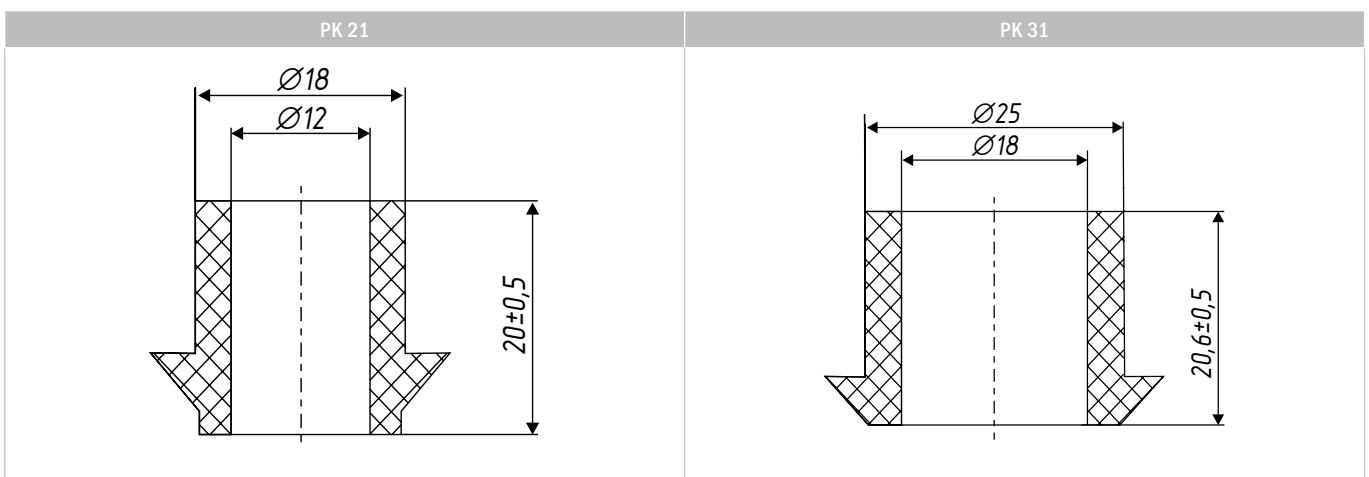

DESIGN PARAMETERS OF CABLE GLANDS KOVTV, KOVTN

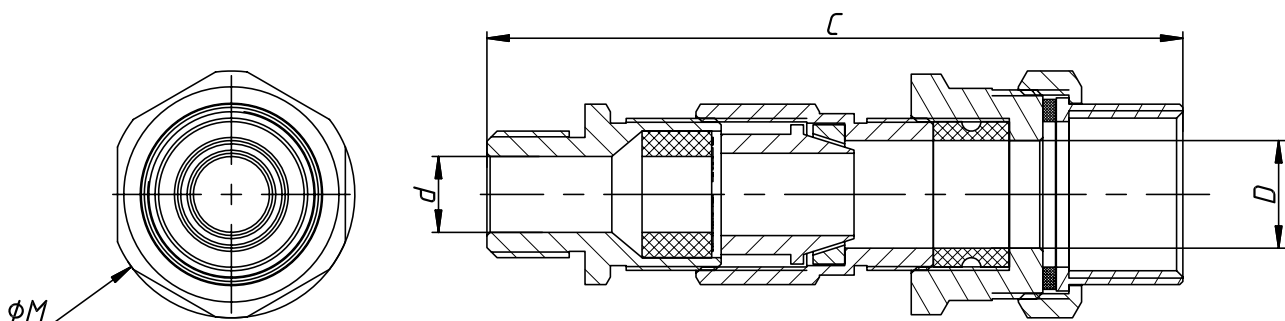

MAIN TECHNICAL DATA OF KOVTV

Dimension type of enclosure	Thread		Dimension sizes*, mm		Diameter of crimped cable, mm	
	M	G, NPT	ØM	C	d	D
01	M16x1,5	3/8"	36	109	3 - 8	8 - 12
1	M20x1,5	1/2"	39	110	6 - 12	9 - 17
2	M25x1,5	3/4"	47	128	12 - 18	15 - 25
2.../P	M25x1,5	3/4"	47	128	6 - 18	9 - 25
3	M32x1,5	1"	58	140	18 - 25	21 - 31
3.../P	M32x1,5	1"	58	140	12 - 25	15 - 31
4	M40x1,5	1 1/4"	65	136	25 - 31	27 - 37
5	M50x1,5	1 1/2"	76	153	31 - 39	36 - 46
6	M63x1,5	2"	96	165	39 - 47	45 - 53

* Information for reference.

MAIN TECHNICAL DATA OF KOVTN

Dimension type of enclosure	Thread		Dimension sizes*, mm		Diameter of crimped cable, mm	
	M	G, NPT	ØM	C	d	D
01	M16x1,5	3/8"	36	115	3 - 8	8 - 12
1	M20x1,5	1/2"	39	118	6 - 12	9 - 17
2	M25x1,5	3/4"	47	134	12 - 18	15 - 25
2.../P	M25x1,5	3/4"	47	134	6 - 18	9 - 25
3	M32x1,5	1"	58	145	18 - 25	21 - 31
3.../P	M32x1,5	1"	58	145	12 - 25	15 - 31
4	M40x1,5	1 1/4"	65	144	25 - 31	27 - 37
5	M50x1,5	1 1/2"	76	155	31 - 39	36 - 46
6	M63x1,5	2"	96	169	39 - 47	45 - 53

* Information for reference.

DIMENSION TYPE OF EXTERNAL THREAD

Dimension type of external thread	Thread	
	M	G, NPT
01	M16x1,5	3/8"
1	M20x1,5	1/2"
2	M25x1,5	3/4"
3	M32x1,5	1"
4	M40x1,5	1 1/4"
5	M50x1,5	1 1/2"
6	M63x1,5	2"
7	M75x1,5	2 1/2"
71	M75x1,5	2 1/2"
8	M90x1,5	3"
81	M90x1,5	3"

SEALING RINGS APPLIED IN CABLE GLANDS

Type of cable gland	Type of sealing ring	Diameter of crimped cable d, mm
KOV...01	PK 01	3 - 8
KOV...011	PK 1	6 - 11
KOV...1	PK 1	6 - 12
KOV...12	PK 1	6 - 12
KOV...12.../P	PK 1	6 - 12
KOV...11	PK 2	12 - 15
KOV...11.../P	PK 21 / PK 2	3 - 15
KOV...2	PK 2	12 - 18
KOV...2.../P	PK 21 / PK 2	6 - 18
KOV...22	PK 2	12 - 18
KOV...22.../P	PK 21 / PK 2	6 - 18
KOV...21	PK 3	18 - 20
KOV...21.../P	PK 31 / PK 3	7 - 20
KOV...3	PK 3	18 - 25
KOV...3.../P	PK 31 / PK 3	12 - 25
KOV...32	PK 3	18 - 25
KOV...32.../P	PK 31 / PK 3	12 - 25
KOV...31	PK 4	25 - 27
KOV...4	PK 4	25 - 31
KOV...42	PK 4	25 - 31
KOV...41	PK 5	31 - 34
KOV...5	PK 5	31 - 39
KOV...52	PK 5	31 - 39
KOV...51	PK 6	39 - 42
KOV...6	PK 6	39 - 47
KOV...7	PK 7	47 - 55
KOV...71	PK 71	55 - 63
KOV...8	PK 8	63 - 71
KOV...81	PK 81	71 - 79

FORMATION OF MARKING

KOVTV X1 X2 X3 X4 X5 / X6



Options, accessories and versions: 316 – material, stainless steel AISI 316; A31– ground ring; KG – locknut ; UKF - external sealant; external sealing ring - P

Cable gland material: nickel-plated brass - NK, stainless steel - N, brass - K, galvanized steel - O

Type of thread for thread of external connection**: National Standard Taper Pipe Thread - N; metric - M; British Standard Pipe Parallel Thread – G

Dimension type of external connection*

Type of thread of connection threaded: National Standard Taper Pipe Thread - N; metric - M; British Standard Pipe Parallel Thread – G

Dimension type of connecting thread

Type of cable gland: KOVTV, KOVTN

*Code of dimension type of external thread is not indicated if it coincides with connecting thread.

**Code of type of external thread is not indicated if the type and dimension type of external thread coincide with connecting thread.



VZN

- Allow to close unused cable entries

VZV

- Allow to close the unused cable entries of the metal hoses

MATERIALS

Product name	Aluminum	Stainless steel	Galvanized steel	Brass	Nickel-plated brass
VZ... series blanking elements	+	+	+	+	+





CERTIFICATION DATA

Zones for installation

Zone 1 - Zone 2 (Gas)

Zone 21 - Zone 22 (Dust)

Version

IECEX	Ex db IIC Gb Ex eb IIC Gb Ex nR IIC Gc Ex tb IIIC Db		VZ... series blanking elements
ATEX	 II 2 G Ex db IIC Gb  II 2 G Ex eb IIC Gb  II 3 G Ex nR IIC Gc  II 2 D Ex tb IIIC Db		

Certification

IECEX CCVE 18.0014X

EESF 19 ATEX 025X

All **IECEX** and **ATEX** certification data can be downloaded from www.en.exd.ru

Conformance standards

Devices are manufactured in accordance with the requirements of IEC 60079-0:2011, IEC 60079-1:2014, IEC 60079-31:2013, IEC 60079-7:2006, IEC 60079-15:2010, EN 60079-0:2012, EN 60079-1:2014, EN 60079-31:2014, EN 60079-7:2007, EN 60079-15:2010, Directive 2014/34/EU ATEX and conform to them.

Service temperature



OPERATION IN ACCORDANCE WITH STANDARDS

Blanking elements are used as part of equipment of stationary and portable electrical installations inside and outside production facilities.

Blanking elements can be used in the enclosures and equipment with the following types of explosion protection: “db”, “eb”, “n”, “t”.

TECHNICAL CHARACTERISTICS OF VZ... SERIES BLANKING ELEMENTS

Dimension type		Metric thread M	Taper inch thread NPT	Pipe cylindrical thread G*
VZN	VZV			
VZN02	-	M12×1,5	1/4"	1/4"
VZN01	-	M16×1,5	3/8"	3/8"
VZN1	VZV1	M20×1,5	1/2"	1/2"
VZN2	VZV2	M25×1,5	3/4"	3/4"
VZN3	VZV3	M32×1,5	1"	1"
VZN4	VZV4	M40×1,5	1 ¼"	1 ¼"
VZN5	VZV5	M50×1,5	1 ½"	1 ½"
VZN6	VZV6	M63×1,5	2"	2"
VZN7	VZV7	M75×1,5	2 ½"	2 ½"
VZN8	VZV8	M90×1,5	3"	3"
VZN10	VZV10	M100×1,5	4"	4"

*Pipe cylindrical thread G is not applicable for products with explosion protection marking Ex db IIC Gb.

Explosion-proof blanking elements are used for closing of pipe ends or unused holes. Blanking elements can be removed only with use of the tools according to para. 16.4 IEC 60079-0.

Absence of foreign objects near threaded entries shall be checked before installation of blanking elements. Additional fastening is not required for installation of blanking elements into threaded entries with more than 5 turns of thread. VZN blanking elements with taper thread are fastened with use of PG-REZBA-F sealant, VZN blanking elements with cylindrical thread are fastened with use of KG type locknut and PG-REZBA-F sealant. Part of the blanking elements without thread shall be completely installed into the entry. Number of continuous turns of thread after installation of blanking elements into equipment shall be not less than 5 in accordance with IEC 60079-1.

FORMATION OF MARKING

Structure of designation of blanking elements VZN

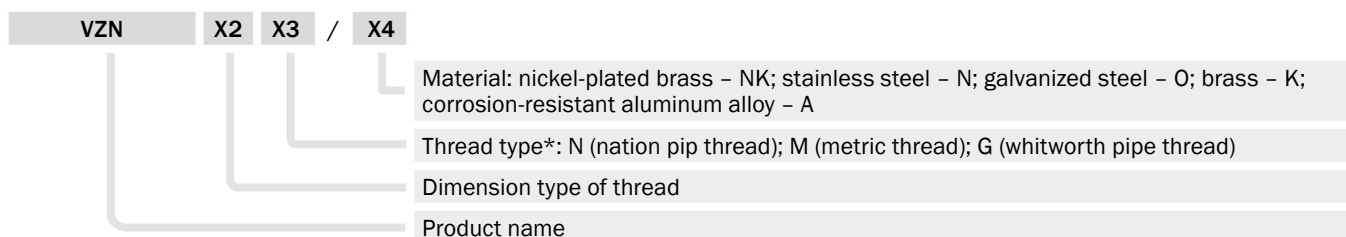

Structure of designation of blanking elements VZV

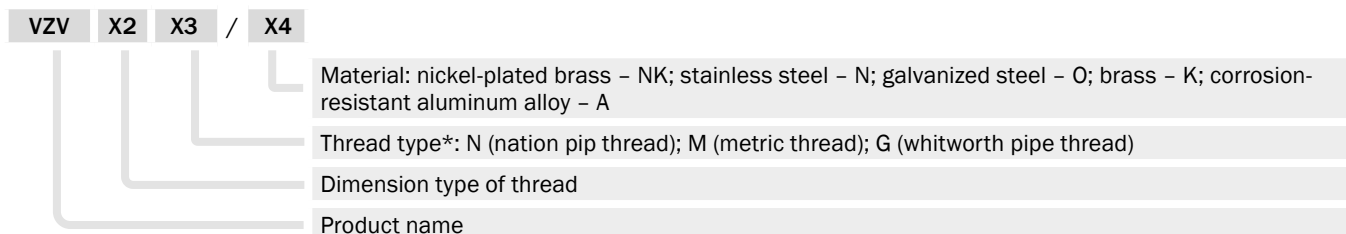

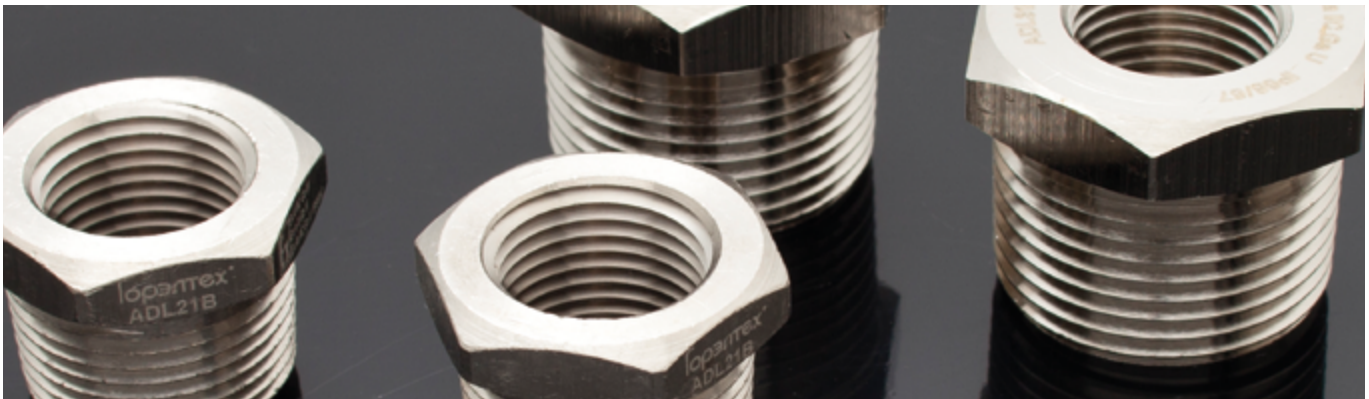

- Are used to change the diameter and/or change the thread type of cable entries

MATERIALS

Product name	Aluminum	Stainless steel	Galvanized steel	Brass	Nickel-plated brass
AV... series adapters	+	+	+	+	+





Sealant is used for provision of degree of protection IP66/67. For AV... series adapters encapsulation with compound is permitted.

CERTIFICATION DATA

Zones for installation

Zone 1 - Zone 2 (Gas) Zone 21 - Zone 22 (Dust)

Version

IECEX	Ex db IIC Gb Ex eb IIC Gb Ex nR IIC Gc Ex tb IIIC Db		AV... series adapters
ATEX	 II 2 G Ex db IIC Gb  II 2 G Ex eb IIC Gb  II 3 G Ex nR IIC Gc  II 2 D Ex tb IIIC Db		

Certification

IECEX CCVE 18.0014X All **IECEX** and **ATEX** certification data can be downloaded from www.en.exd.ru
 EESF 19 ATEX 025X

Conformance standards

Devices are manufactured in accordance with the requirements of IEC 60079-0:2011, IEC 60079-1:2014, IEC 60079-31:2013, IEC 60079-7:2006, IEC 60079-15:2010, EN 60079-0:2012, EN 60079-1:2014, EN 60079-31:2014, EN 60079-7:2007, EN 60079-15:2010, Directive 2014/34/EU ATEX and conform to them.

Service temperature



OPERATION IN ACCORDANCE WITH STANDARDS

Blanking elements are used as part of equipment of stationary and portable electrical installations inside and outside production facilities.

TECHNICAL CHARACTERISTICS OF AV... ADAPTER

Input thread diameter D1		Output thread diameter, D2												
		Dimension type of thread			02	01	1	2	3	4	5	6	7	8
		M	N	G**	M12×1,5	M16×1,5	M20×1,5	M25×1,5	M32×1,5	M40×1,5	M50×1,5	M63×1,5	M75×1,5	M90×1,5
02	M12×1,5	1/4"	1/4"	x										
01	M16×1,5	3/8"	3/8"	x	x									
1	M20×1,5	1/2"	1/2"	x	x	x								
2	M25×1,5	3/4"	3/4"	x	x	x	x							
3	M32×1,5	1"	1"	x	x	x	x	x						
4	M40×1,5	1 1/4"	1 1/4"	x	x	x	x	x	x					
5	M50×1,5	1 1/2"	1 1/2"		x	x	x	x	x	x				
6	M63×1,5	2"	2"			x	x	x	x	x	x			
7	M75×1,5	2 1/2"	2 1/2"				x	x	x	x	x	x		
8	M90×1,5	3"	3"					x	x	x	x	x	x	

**Pipe cylindrical thread G is not applicable for products with explosion protection marking Ex db IIC Gb.

AV explosion-proof adapters are intended for connection of the equipment, pipes and entries of various diameter and various type of thread and also for transformation of internal thread to external and vice versa.

FORMATION OF MARKING

Structure of designation of adapters AV

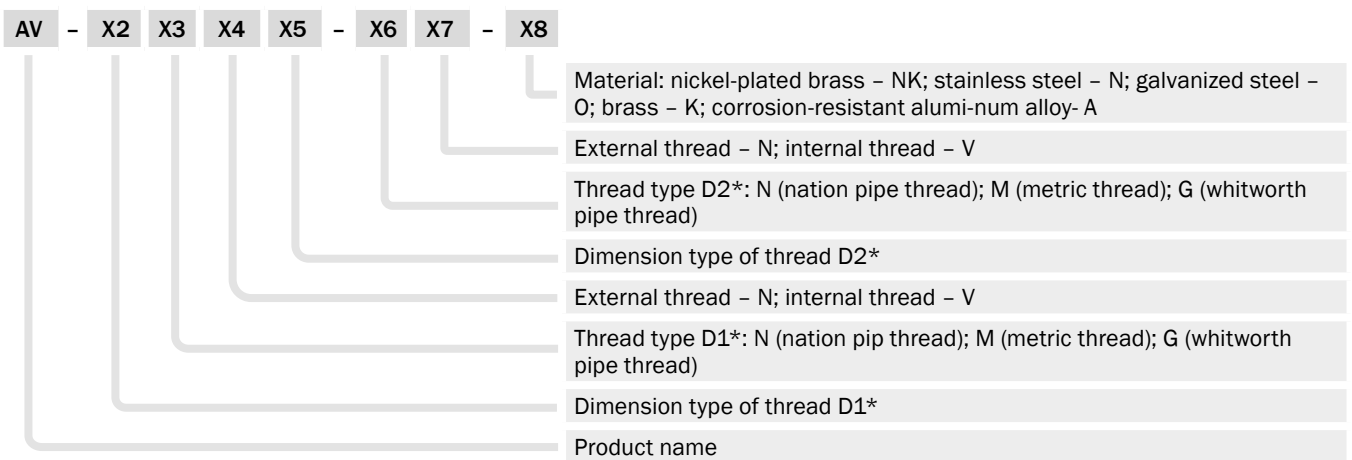

*Pipe cylindrical thread G is not applicable for products with explosion protection marking Ex db IIC Gb.

**DKUV**

- Applies with partition fittings and other explosion-proof electrical equipment to ensure condensate draining and gas releases
- Combines condensate draining and correction of atmospheric pressure fluctuations
- Prevents accumulation of moist in the enclosure during seasonal and industrial temperature changes

DKUE

- Combines condensate draining and correction of atmospheric pressure fluctuations
- Prevents accumulation of moist in the enclosure during seasonal and industrial temperature changes
- Manufactured with a built-in filter which prevents penetration of dust into enclosure
- Special grooves in thread and serrated locknut allow safe draining and full removal of condensate accumulating on the bottom of the enclosure

VKU

- Applies in explosion-proof equipment to enable gas release and to decrease gas pressure in storage batteries
- Allows to correct atmospheric pressure fluctuations
- Should be installed in the upper part of the enclosure only

MATERIALS











Product name	Aluminum	Stainless steel	Galvanized steel	Brass	Nickel-plated brass
DKUV drain plugs	-	+	+	+	+
DKUE drain plugs	+	+	+	+	+
VKU breather plugs	-	+	+	+	+

CERTIFICATION DATA**Zones for installation**

Zone 1 - Zone 2 (Gas)

Zone 21 - Zone 22 (Dust)

Version

IECEX	Ex db IIB Gb Ex tb IIIC Db		DKUV drain plugs
ATEX	 II 2 G Ex db IIB Gb  II 2 D Ex tb IIIC Db		
IECEX	Ex eb IIC Gb Ex tb IIIC Db		DKUE drain plugs
ATEX	 II 2 G Ex eb IIC Gb  II 2 D Ex tb IIIC Db		
IECEX	Ex db IIC Gb Ex eb IIC Gb Ex tb IIIC Db		VKU breather plugs
ATEX	 II 2 G Ex db IIC Gb  II 2 G Ex eb IIC Gb  II 2 D Ex tb IIIC Db		

Certification

IECEX CCVE 18.0014X

EESF 19 ATEX 025X

All **IECEX** and **ATEX** certification data can be downloaded from www.en.exd.ru

Conformance standards

Devices are manufactured in accordance with the requirements of IEC 60079-0:2011, IEC 60079-1:2014, IEC 60079-31:2013, IEC 60079-7:2006, IEC 60079-15:2010, EN 60079-0:2012, EN 60079-1:2014, EN 60079-31:2014, EN 60079-7:2007, EN 60079-15:2010, Directive 2014/34/EU ATEX and conform to them.

Service temperature

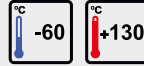

OPERATION IN ACCORDANCE WITH STANDARDS

Blanking elements are used as part of equipment of stationary and portable electrical installations inside and outside production facilities.

TECHNICAL CHARACTERISTICS OF DK... SERIES DRAIN PLUGS AND VK... SERIES BREATHER PLUGS

Dimension type of DKUV	Dimension type of DKUE	Dimension type of VKU	Metric thread M	Taper inch thread NPT	Pipe cylindrical thread G*
DKUV01	-	VKU01	M16×1,5	3/8"	3/8"
DKUV1	DKUE	VKU1	M20×1,5	1/2"	1/2"

*Pipe cylindrical thread G is not applicable for products with explosion protection marking Ex db IIC Gb.

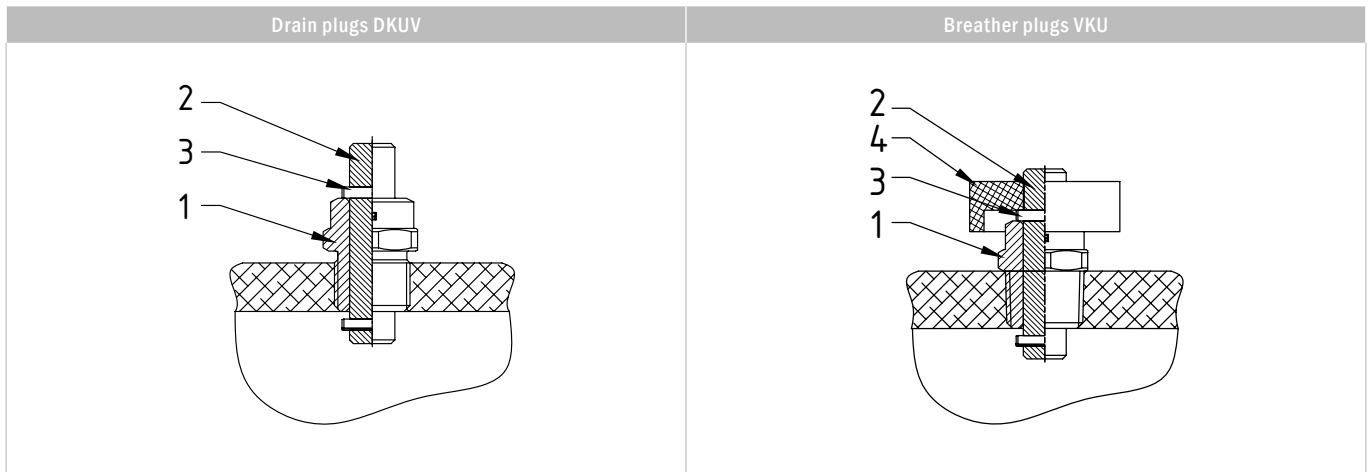

Drain plugs DK... and breather plugs VK... are applied for condensate removal, gas removal and correction of differential atmospheric pressure. Drain plugs DKUE are manufactured with built-in filter which prevents ingress of dust inside enclosure. Special grooves in the thread and serrated locknut enable to perform high-quality and safe backhand drainage. Installation of DKUV drain plug is allowed in the bottom part of the enclosure only. Breather plugs VKU can be applied for removal of excess pressure of gases of accumulators and they shall be installed only vertically in the upper part of the enclosure.

FORMATION OF MARKING

Structure of designation of DK... series drain plugs and VK... series breather plugs

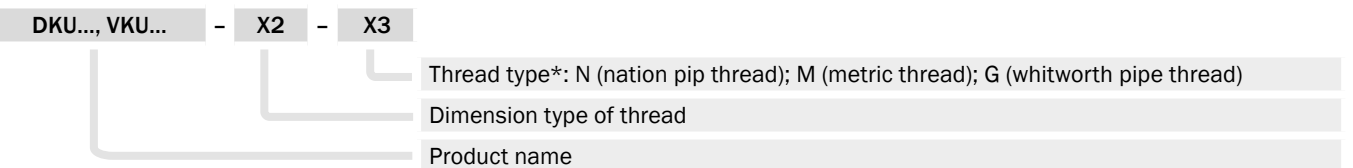

*Pipe cylindrical thread G is not applicable for products with explosion protection marking Ex db IIC Gb.

Full designation of the drain plug DKUE: DKUE. When applying DKUE drain plugs as breather plugs, use the designation VKUE.

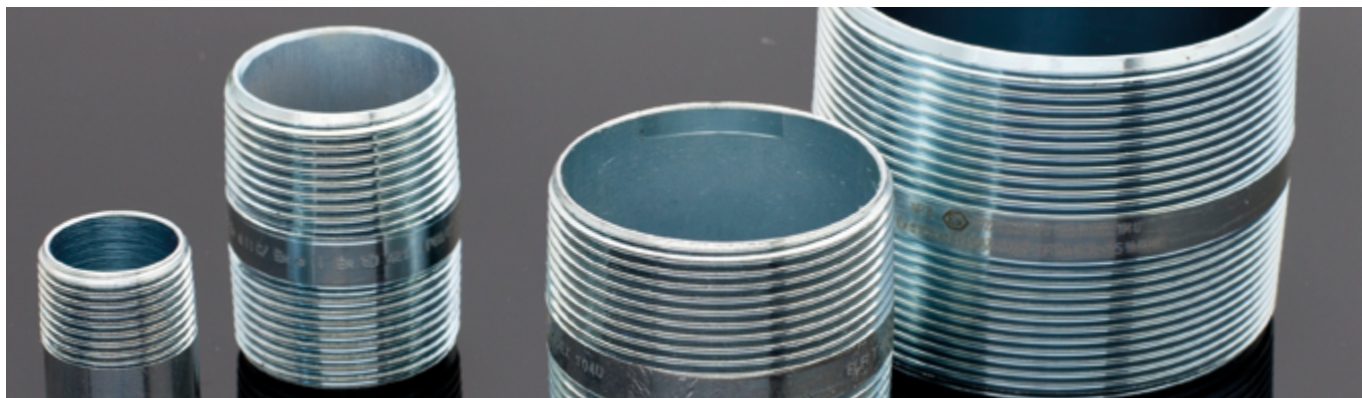

- Connecting coupling is applied for connection of equipment and elements of pipe conduits of the same diameter
- The coupling may be used to fix problems with mounting pipe systems of electrical wiring

MATERIALS

Product name	Aluminum	Stainless steel	Galvanized steel	Brass	Nickel-plated brass
NV... series nipples and bushings	+	+	+	+	+

Sealant is used for provision of degree of protection IP66/67. For AV... series adapters encapsulation with compound is permitted.





CERTIFICATION DATA

Zones for installation

Zone 1 - Zone 2 (Gas)

Zone 21 - Zone 22 (Dust)

Version

IECEX	Ex db IIC Gb Ex eb IIC Gb Ex nR IIC Gc Ex tb IIIC Db		NV... series nipples and bushings
ATEX	 II 2 G Ex db IIC Gb  II 2 G Ex eb IIC Gb  II 3 G Ex nR IIC Gc  II 2 D Ex tb IIIC Db		

Certification

IECEX CCVE 18.0014X

EESF 19 ATEX 025X

All **IECEX** and **ATEX** certification data can be downloaded from www.en.exd.ru

Conformance standards

Devices are manufactured in accordance with the requirements of IEC 60079-0:2011, IEC 60079-1:2014, IEC 60079-31:2013, IEC 60079-7:2006, IEC 60079-15:2010, EN 60079-0:2012, EN 60079-1:2014, EN 60079-31:2014, EN 60079-7:2007, EN 60079-15:2010, Directive 2014/34/EU ATEX and conform to them.

Service temperature



OPERATION IN ACCORDANCE WITH STANDARDS

Blanking elements are used as part of equipment of stationary and portable electrical installations inside and outside production facilities.

TECHNICAL CHARACTERISTICS OF NV... SERIES NIPPLES AND BUSHINGS

Dimension type of NVN	Dimension type of NVV	Metric thread M	Taper inch thread NPT	Pipe cylindrical thread G*
NVN02	NVV02	M12×1,5	1/4"	1/4"
NVN01	NVV01	M16×1,5	3/8"	3/8"
NVN1	NVV1	M20×1,5	1/2"	1/2"
NVN2	NVV2	M25×1,5	3/4"	3/4"
NVN3	NVV3	M32×1,5	1"	1"
NVN4	NVV4	M40×1,5	1 ¼"	1 ¼"
NVN5	NVV5	M50×1,5	1 ½"	1 ½"
NVN6	NVV6	M63×1,5	2"	2"
NVN7	NVV7	M75×1,5	2 ½"	2 ½"
NVN8	NVV8	M90×1,5	3"	3"
NVN10	NVV10	M100×1,5	4"	4"

*Pipe cylindrical thread G is not applicable for products with explosion protection marking Ex db IIC Gb.

NV... nipples and bushings are intended for coupling; nipples – for the equipment with internal thread, bushings – for the equipment with external thread.

FORMATION OF MARKING

Structure of designation of nipples and bushings NV

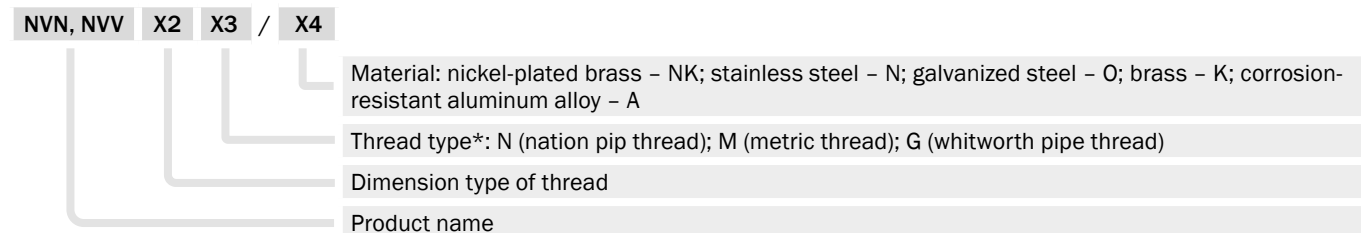

*Pipe cylindrical thread G is not applicable for products with explosion protection marking Ex db IIC Gb.



- Partition fittings with compound filling are applied in pipe systems of electrical wiring for partition sealing of separate sections while mounting in pipe systems and local leak tightness tests in pipe systems of electrical wiring

MATERIALS

Product name	Aluminum	Stainless steel
RZ... series fitting joints	+	+

Sealant is used for provision of degree of protection IP66/67. For RZ... series fittings encapsulation with compound is permitted.

The coating for the enclosures of RZ... series fitting joints made of aluminum: thermosetting powder. Method of application: electrostatic spray gun or tribostatic gun.

CERTIFICATION DATA

Zones for installation

Zone 1 - Zone 2 (Gas)	Zone 21 - Zone 22 (Dust)
-----------------------	--------------------------

Version

<p>IECEX</p> <p>Ex db IIC Gb Ex eb IIC Gb Ex nR IIC Gc Ex tb IIIC Db</p>	 <p>RZ... series fitting joints</p>
<p>ATEX</p> <p>⊕ II 2 G Ex db IIC Gb ⊕ II 2 G Ex eb IIC Gb ⊕ II 3 G Ex nR IIC Gc ⊕ II 2 D Ex tb IIIC Db</p>	

Certification

IECEX CCVE 18.0014X	All IECEX and ATEX certification data can be downloaded from www.en.exd.ru
EESF 19 ATEX 025X	

Conformance standards

Devices are manufactured in accordance with the requirements of IEC 60079-0:2011, IEC 60079-1:2014, IEC 60079-31:2013, IEC 60079-7:2006, IEC 60079-15:2010, EN 60079-0:2012, EN 60079-1:2014, EN 60079-31:2014, EN 60079-7:2007, EN 60079-15:2010, Directive 2014/34/EU ATEX and conform to them.

Service temperature

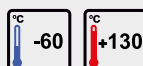

OPERATION IN ACCORDANCE WITH STANDARDS

Blanking elements are used as part of equipment of stationary and portable electrical installations inside and outside production facilities.

TECHNICAL CHARACTERISTICS OF RZ... FITTING JOINTS

Dimension type of RZV	Dimension type of RZG	Metric thread M	Taper inch thread NPT	Pipe cylindrical thread G*	Amount of compound for RZV, g	Amount of compound, for RZG, g	Fibers, g
RZV1	RZG1	M20×1,5	1/2"	1/2"	35	140	1,5
RZV2	RZG2	M25×1,5	3/4"	3/4"	50	140	2,5
RZV3	RZG3	M32×1,5	1"	1"	100	140	5
RZV4	RZG4	M40×1,5	1 1/4"	1 1/4"	240	390	15
RZV5	RZG5	M50×1,5	1 1/2"	1 1/2"	240	450	30
RZV6	RZG6	M63×1,5	2"	2"	380	570	50
RZV7	RZG7	M75×1,5	2 1/2"	2 1/2"	1250	1000	90
RZV8	RZG8	M90×1,5	3"	3"	1350	1250	1,5
RZV10	RZG10	M100×1,5	4"	4"	1450	1400	2,5

*Pipe cylindrical thread G is not applicable for products with explosion protection marking Ex db IIC Gb.

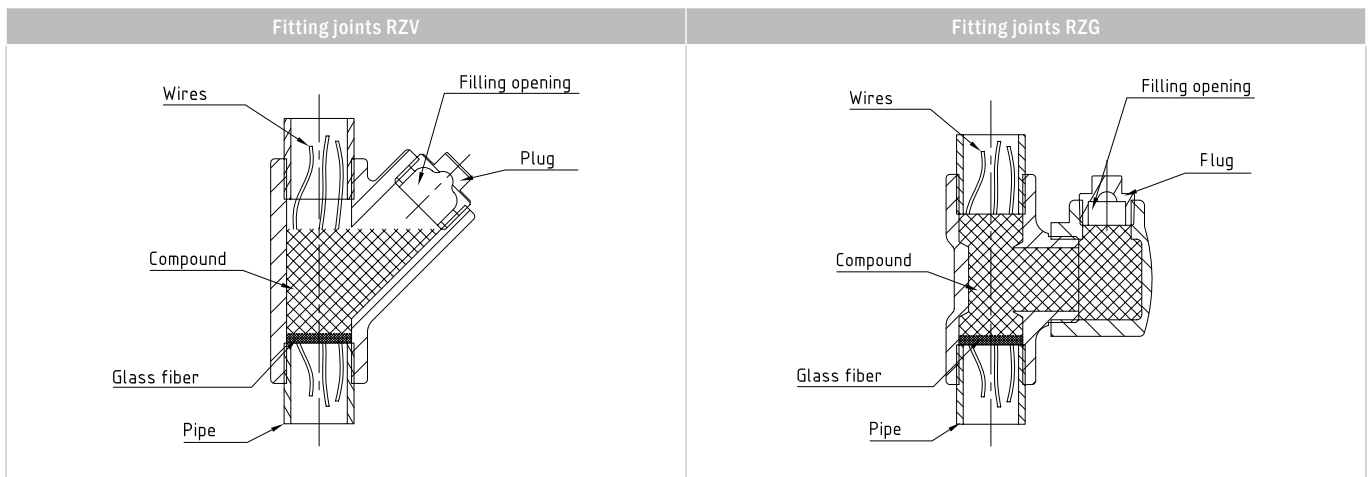

RZV and RZG fitting joints are intended for separation of gas mixture when it flows through piping systems from one part of the electrical equipment to another. Besides, fitting joints are used for the separation of the internal volume of the separate explosion-proof enclosure of electrical equipment, and also for separation from the internal volume of the piping system of the wiring. Fitting joints are mounted as close as possible to explosion-proof enclosures. RZV type fitting joints are applied for vertical installation, RZG – for horizontal installation.

FORMATION OF MARKING

Structure of designation of fitting joints RZV, RZG

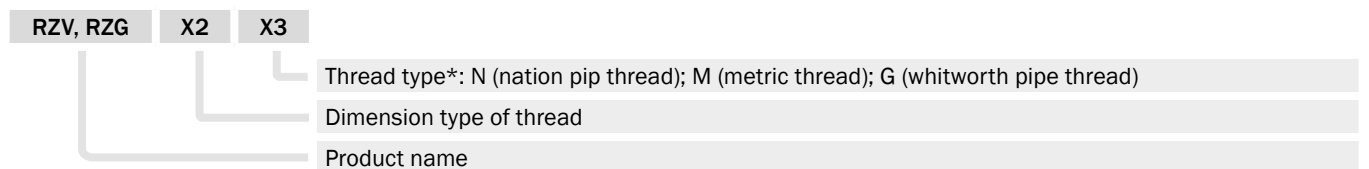

*Pipe cylindrical thread G is not applicable for products with explosion protection marking Ex db IIC Gb.



- Explosion-proof fitting connections are used in pipe systems of electrical wiring in places with high risk of explosion
- It ensures independent rotation and allows to connect pipes, boxes and other elements of pipe systems of electrical wiring

MATERIALS

Product name	Aluminum	Stainless steel	Galvanized steel	Brass	Nickel-plated brass
TS... series fitting joints	+	+	+	+	+









Sealant is used for provision of degree of protection IP66/67.

CERTIFICATION DATA

Zones for installation

Zone 1 - Zone 2 (Gas) Zone 21 - Zone 22 (Dust)

Version

IECEX	Ex db IIB Gb Ex eb IIC Gb Ex tb IIIC Db		TSVV, TSNN, TSVN fitting joints
ATEX	 II 2 G Ex db IIC Gb  II 2 G Ex eb IIC Gb  II 2 D Ex tb IIIC Db		
IECEX	Ex db IIC Gb Ex eb IIC Gb Ex tb IIIC Db		TSVVA, TSNNA, TSVNA fitting joints
ATEX	 II 2 G Ex db IIC Gb  II 2 G Ex eb IIC Gb  II 2 D Ex tb IIIC Db		

Certification

IECEX CCVE 18.0014X All **IECEX** and **ATEX** certification data can be downloaded from
 EESF 19 ATEX 025X www.en.exd.ru

Conformance standards

Devices are manufactured in accordance with the requirements of IEC 60079-0:2011, IEC 60079-1:2014, IEC 60079-31:2013, IEC 60079-7:2006, IEC 60079-15:2010, EN 60079-0:2012, EN 60079-1:2014, EN 60079-31:2014, EN 60079-7:2007, EN 60079-15:2010, Directive 2014/34/EU ATEX and conform to them.

Service temperature

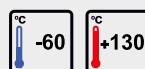

OPERATION IN ACCORDANCE WITH STANDARDS

Blanking elements are used as part of equipment of stationary and portable electrical installations inside and outside production facilities.

TECHNICAL CHARACTERISTICS OF FITTING JOINTS TS...

Dimension type of thread		Output thread diameter, D2*											
		1	2	3	4	5	6	7	8	9	10		
		M20×1,5	M25×1,5	M32×1,5	M40×1,5	M50×1,5	M63×1,5	M75×1,5	M90×1,5	M95×1,5	M100×1,5		
M	N	1/2"	3/4"	1"	1 ¼"	1 ½"	2"	2 ½"	3"	3 ½"	4"		
	G*	1/2"	3/4"	1"	1 ¼"	1 ½"	2"	2 ½"	3"	3 ½"	4"		
Input thread diameter D1*	1	M20×1,5	1/2"	1/2"	x								
	2	M25×1,5	3/4"	3/4"	x								
	3	M32×1,5	1"	1"	x								
	4	M40×1,5	1 ¼"	1 ¼"	x								
	5	M50×1,5	1 ½"	1 ½"	x								
	6	M63×1,5	2"	2"	x								
	7	M75×1,5	2 ½"	2 ½"	x								
	8	M90×1,5	3"	3"	x								
	9	M95×1,5	3 ½"	3 ½"	x								
	10	M100×1,5	4"	4"	x								

*Pipe cylindrical thread G is not applicable for products with explosion protection marking Ex db IIC Gb

TS... fitting joints are used for input of pipes. TSNN, TSVV, TSVN fitting joints are applicable for IIB gas group, TSNNA, TSVVA, TSVNA fitting joints are applicable for IIC gas group.

FORMATION OF MARKING

Structure of designation of adapters AV

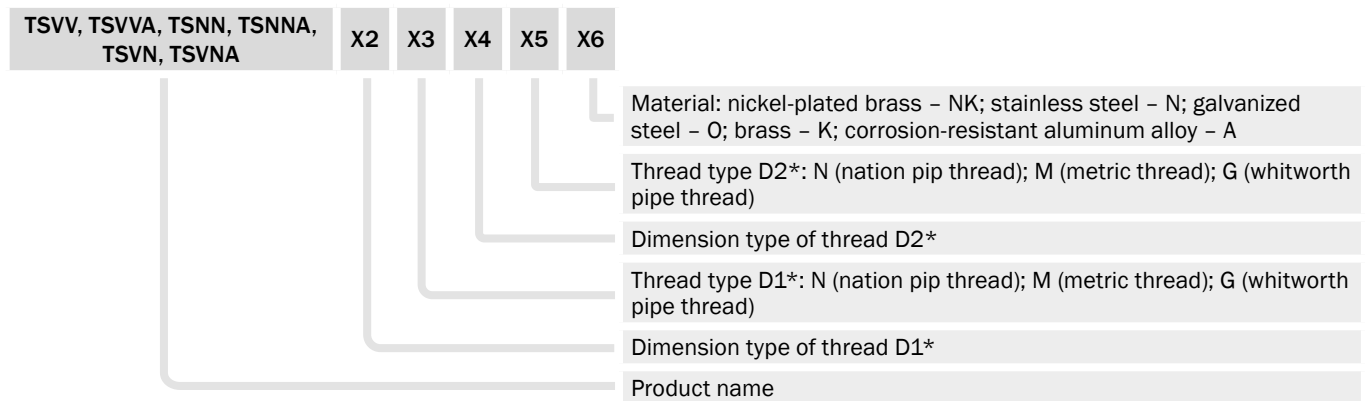

*Pipe cylindrical thread G is not applicable for products with explosion protection marking Ex db IIC Gb.

HAZARDOUS AREA CLASSIFICATIONS

When electrical equipment is used in, around, or near an atmosphere that has flammable gases or vapors, flammable liquids, combustible dusts, ignitable fibers or flyings, there is always a possibility or risk that a fire or explosion might occur. Those areas where the possibility or risk of fire or explosion might occur due to an explosive atmosphere and/or mixture is often called a hazardous (or classified) location/area.

Currently there are two systems used to classify these hazardous areas: the Class/Division system and the Zone system. The Class/Division system is used predominately in the United States and Canada, whereas the rest of the world generally uses the Zone system. However, the United States and Canada are trending more towards the Zone System.

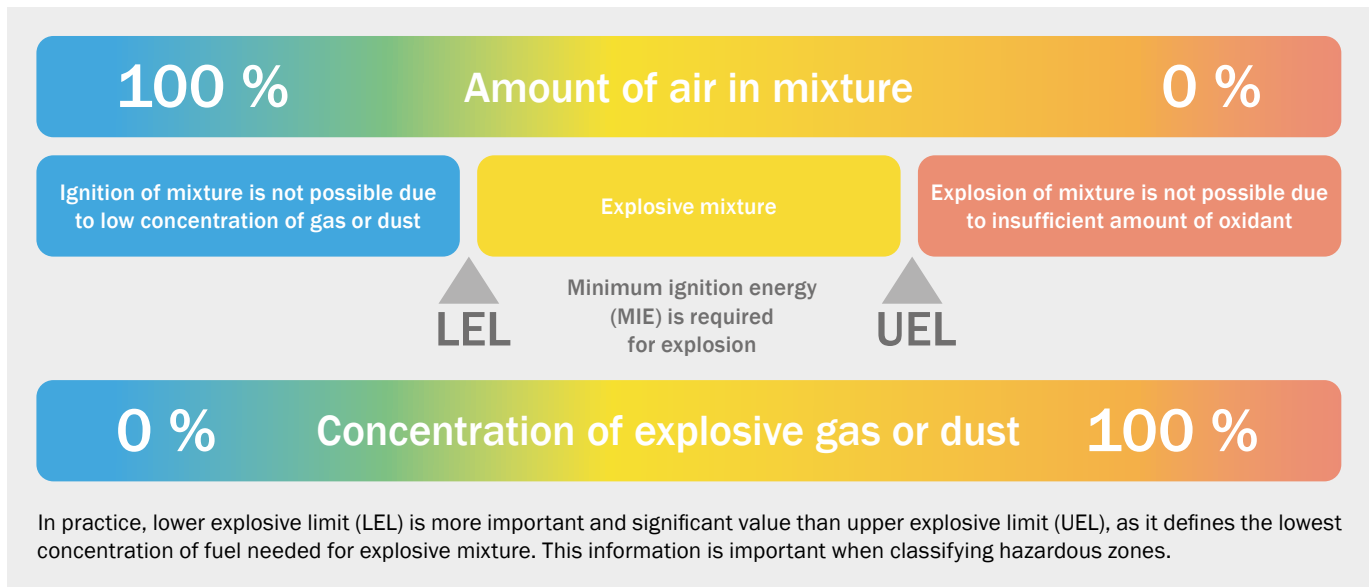

POTENTIAL IGNITION SOURCES OF HAZARDOUS AREA

- sparks (electrical and friction), flame, high temperature of heated surface;
- static electricity (electrostatic charges that may cause dangerous discharges);
- stray current and leakage current that may cause dangerous corrosion, sparks or overheating of surface that may lead to ignition;
- overheating as the result of tension and impacts that may arise between materials and parts contacting with each other while rotating or in case of ingress of foreign objects;
- pressure suppression which is performed by adjustment devices and can cause shock waves or compressions that lead to ignition;
- lightning strokes;
- exothermic reaction, including self-ignition of dust.

ZONE SYSTEM

Hazardous locations per the Zone system are classified according to its Zone which can be gas or dust. For gas atmospheres electrical equipment is further divided into Groups and Subgroups.

ZONE

The Zone defines the probability of the hazardous material, gas or dust, being present in sufficient quantities to produce explosive or ignitable mixtures.

1. Gas

- Zone 0** – Ignitable concentrations of flammable gases or vapors which are present continuously or for long periods of time.
- Zone 1** – Ignitable concentrations of flammable gases or vapors which are likely to occur under normal operating conditions.
- Zone 2** – Ignitable concentrations of flammable gases or vapors which are not likely to occur under normal operating conditions and do so only for a short period of time.

2. Dust

- Zone 20** – An area where combustible dusts or ignitable fibers and flyings are present continuously or for long periods of time.
- Zone 21** – An area where combustible dusts or ignitable fibers and flyings are likely to occur under normal operating conditions.
- Zone 22** – An area where combustible dusts or ignitable fibers and flyings are not likely to occur under normal operating conditions and do so only for a short period of time.

GROUP

Electrical equipment is divided into three groups .

Group I – Equipment intended for use in mines susceptible to firedamp (flammable mixture of gases naturally occurring in a mine).

Group II – Equipment intended for use in places with an explosive gas atmosphere other than mines susceptible to firedamp. Group II equipment is subdivided into three subgroups.

- Group IIA – Atmospheres containing propane, or gases and vapors of equivalent hazard.
- Group IIB – Atmospheres containing ethylene, or gases and vapors of equivalent hazard.
- Group IIC – Atmospheres containing acetylene or hydrogen, or gases and vapors of equivalent hazard.

Group III – Equipment intended for use in places with an explosive dust atmosphere. Group III equipment is subdivided into three subgroups.

- Group IIIA – Atmospheres containing combustible flyings.
- Group IIIB – Atmospheres containing non-conductive dust.
- Group IIIC – Atmospheres containing conductive dust.

EQUIPMENT PROTECTION LEVEL (EPL) MARKINGS POTENTIAL IGNITION SOURCES OF HAZARDOUS AREA

The EPL marking indicates the level of protection that is given to equipment based on the likelihood of its becoming a source of ignition and distinguishing the difference between explosive gas atmospheres, explosive dust atmospheres, and the explosive atmospheres in mines susceptible to firedamp.

Temperature Code (T Code)

A mixture of hazardous gases and air may be ignited by coming into contact with a hot surface. The conditions under which a hot surface will ignite a gas depends on surface area, temperature, and the concentration of the gas. The same can be said about combustible dusts. The T code of a product denotes the maximum surface temperature that a given product will not exceed under a specified ambient temperature. For example, a product with a T code of T3 means that its maximum surface temperature will not exceed 200C provided it is operated in a ambient temperature defined by the manufacturer.

Mixture group	Temperature of self-ignition of explosive atmosphere
T1	more than 450
T2	300-450
T3	200-300
T4	135-200
T5	100-135
T6	85-100

PROTECTION TECHNIQUES AND METHODS

Various protection techniques and methods have been developed and employed, thus reducing or minimizing the potential risks of explosion or fire from electrical equipment located in hazardous locations. The most common methods are listed below.

The below concepts are high-level protection concepts. There are also sub-levels of protection that may or not be applicable to each type. Also, some equipment may combine multiple types of protection.









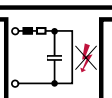

Flame-proof—A type of protection in which an enclosure can withstand the pressure developed during an internal explosion of an explosive mixture and that prevents the transmission of the explosion to the explosive atmosphere surrounding the enclosure and that operates at such an external temperature that a surrounding explosive gas or vapor will not be ignited there. This type of protection is referred to as “Ex d”.

Intrinsically Safe—A type of protection in which the electrical equipment under normal or abnormal conditions is incapable of releasing sufficient electrical or thermal energy to cause ignition of a specific hazardous atmospheric mixture in its most easily ignitable concentrations. This type of protection is referred to as “Ex i”.

Increased Safety—A type of protection in which various measures are applied to reduce the probability of excessive temperatures and the occurrence of arcs or sparks in the interior and on the external parts of electrical apparatus that do not produce them in normal service. Increased safety may be used with flame-proof type of protection. This type of protection is referred to as “Ex e”.

Type n—A type of protection applied to electrical equipment such that in normal operation it is not capable of igniting a surrounding explosive atmosphere. This type of protection is referred to as “Ex n”.

Type t—A type of protection in which the electrical equipment is equipped with an enclosure providing dust ingress protection and a means to limit surface temperatures. This type of protection is referred to as “Ex t”.

Type and concept of explosion protection	Marking	Depiction	Main application
Flameproof enclosure. Spreading of explosion into external atmosphere is excluded.	Ex da, Ex db, Ex dc		Terminal and junction boxes, switching devices, light fixtures, local control stations, switchgear, starters, electric motors, heating elements, control cabinets, IT-equipment. Equipment is intended for category of explosive mixture I for work in mines where there is a possibility of firedamp explosion and mixture II for work under conditions of possible formation of industrial explosive mixtures of gases and dust (according to the recent classification category III – for dust). Equipment of group II is divided into three subgroups: IIA, IIB, IIC
“e” type of protection. Exclusion of spark or increased temperature and arc discharges	Ex ea, Ex eb, Ex ec		Terminal and junction boxes, light fixtures, local control stations, switchgear, heating elements
Intrinsically safe circuit. Limitation of spark energy or increased temperature	Ex ia Ex ib Ex ic (Ex iaD, Ex ibD)		Measuring and regulating instruments, communications equipment, sensors, drives, flashlights with rechargeable batteries. Equipments is intended for category of explosive mixture I for work in mines where there is a possibility of firedamp explosion and mixture II for work under conditions of possible formation of industrial explosive mixtures of gases and dust (according to the recent classification category III – for dust). Equipment with type of protection ia, ib, ic for group II is divided into three subgroups: IIA, IIB, IIC
Filling or purging. Ex-atmosphere is isolated from the source of ignition	Ex pv Ex px Ex py Ex pz		High-current distribution boards, highly integrated IT-equipment, analyzer equipment, superpower electric motors
Encapsulation with compound. Ex-atmosphere is isolated from the source of ignition	Ex ma Ex mb Ex mc (Ex maD, Ex mbD)		Small power switching devices, indicators, sensors. Equipment with type of protection ma, mb, mc for group II is divided into three subgroups: IIA, IIB, IIC
Oil filling of enclosure. Ex-atmosphere is isolated from the source of ignition	Ex o		Transformers, starting resistors, IT-equipment
Powder filling of enclosure. Spreading of explosion into external atmosphere is excluded	Ex q		Transformers, condensers, indicators
“n” type of protection. Equipment and components have no igniting capability. Additional protection against sparking and arc discharges, as well as heated surfaces	Ex n		Ex n equipment is divided into five types: A – for non-sparking electrical equipment; C – for sparking electrical equipment, contacts of which have explosion protection, except for explosion protection with use of restricted-breathing enclosure, excessive pressure enclosures n or intrinsically safe circuit n; R – for restricted-breathing enclosure; L – for intrinsically safe circuits n and intrinsically safe electrical equipment n; Z – for excessive pressure enclosures n. Equipment with nC or nL marking is divided into three sub-groups: IIA, IIB, IIC
Special protection. For lowering the possibility of electrical sparking	Ex sa, Ex sb, Ex sc		This type of protection can be provided by following means: • Enclosing electric circuits in hermetically sealed enclosure with IP67 degree of protection; • Sealing electrical equipment with material which has insulating properties (compounds, sealants); • Affecting explosive mixture with devices or substances to absorb or lower their concentrations; • Other methods.
Dust ignition protection. Protection by enclosure and surface temperature limitation	Ex ta Ex tb Ex tc		Enclosure must prevent contact of combustible dust with heated/sparking parts of the equipment. Additional measures for equipment temperature limitation are applied for “ta” equipment.
Protection of equipment and systems transmitting optical radiation. Ignition by surfaces heated by the radiation and due to laser-induced gas breakdown in intensive beam focus are excluded	Ex op is Ex op pr Ex op sh		Optical equipment (lamps, lasers, light emitting diodes, optic fiber), communications equipment, geodetic equipment, control and measuring instruments

NOMENCLATURE

Approved equipment is marked according to the protection concept for which it has been designed (Ex i, Ex d, Ex n, and etc.), the group (I, IIA, IIB, IIC, IIIA, IIIB, or IIIC), and temperature code (T1 through T6) that it is rated for. For the United States it will be preceded by which Class and Zone it is approved for.

EUROPEAN MARKING OF EXPLOSION-PROOF EQUIPMENT (ATEX)

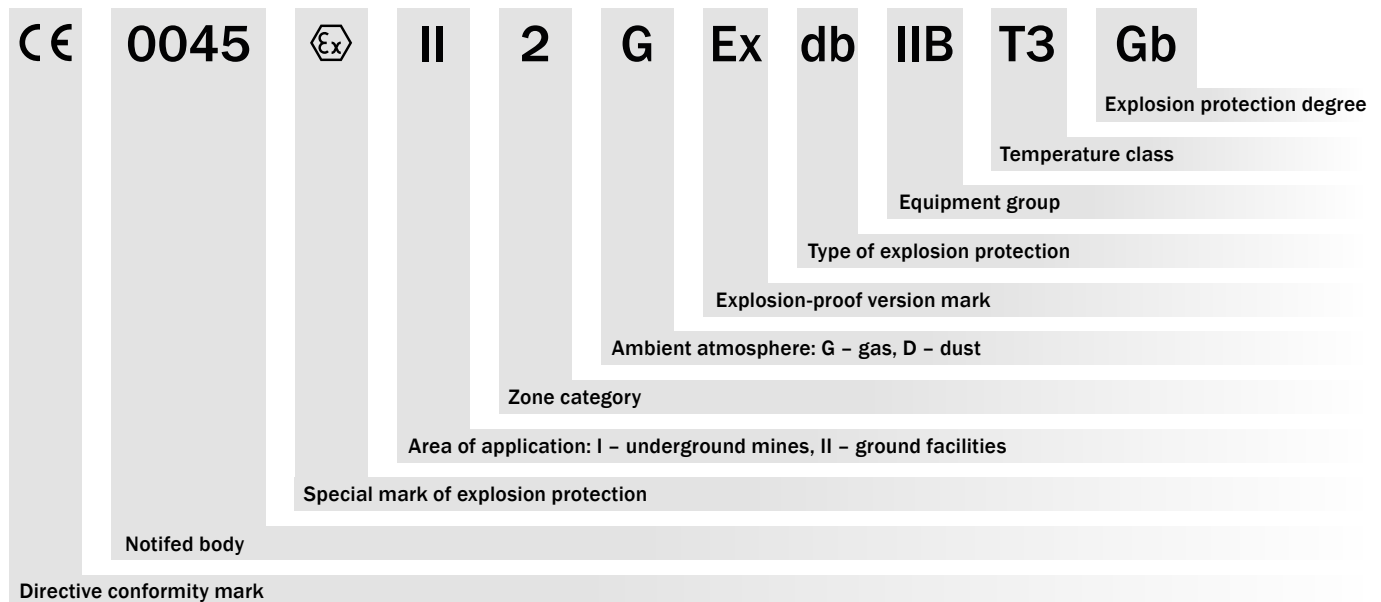

APPROVAL AGENCIES

Generally speaking, most countries require that products intended for installation in a hazardous location be approved by a recognized authority or approval agency (governmental or independent) which that country has established by various laws, regulations, or codes.

European Approvals

Each country belonging to the European Union has established one or more "Notified Bodies" for product approval. Notified Bodies not only approve products for use within their own country, commonly called national certifications/approvals, but also for any other country within the union, known as CENELEC certifications/approvals. CENELEC is the acronym for European Committee for Electrotechnical Standardization. A product which has been CENELEC certified or approved by any of the Notified Bodies is automatically accepted for use within all of the participating union countries. In February 2014 a European Directive, called the ATEX Directive, which pertains to equipment for explosive atmospheres, was adopted. All equipment intended for use in explosive atmospheres must comply with the ATEX Directive in order to be sold into the European Union.

International Approvals

Countries participating in the IECEx Scheme (International Electrotechnical Commission on explosion protected equipment, known as "Ex") can issue either an international certification or a national certification of explosion protected equipment. Each country within the IECEx scheme establishes an ExCB (Ex Certification Body) which can approve products.

ExCB's can issue the national certification for their country based upon the IECEx standards (including any national deviations) and the international certification. Currently, Australia is the only country accepting international certifications for use in their country.

CONTACT US

TOLL FREE NUMBER:

+7 (812) 448-90-90

RUSSIAN FEDERATION, SAINT-PETERSBURG
Head office and manufacturing complex
mail@exd.ru

ZAVOD GORELTEX, liter A, Novosaratovka
township area, Leningrad region, 193149, RUSSIA

RUSSIAN FEDERATION, MOSCOW
Office
mos@exd.ru

ZAVOD GORELTEX, office 15, floor 12, bldg.2,
Imperia Tower, Moscow International Business
Center "Moscow City", Presnenskaya
naberezhnaya, 6, Moscow, 123112, RUSSIA

RUSSIAN FEDERATION, KAZAN
Office
kazan@exd.ru

ZAVOD GORELTEX, office 1110, floor 11, Business
center «Korston», ul. Nikolaya Ershova, 1A, Kazan,
420061, RUSSIA

RUSSIAN FEDERATION, TYUMEN
Office and manufacturing site
tyumen@exd.ru

ZAVOD GORELTEX, ul. Shcherbakova, 160G,
Tyumen, 625031, RUSSIA

RUSSIAN FEDERATION, KHABAROVSK
Office
habarovsk@exd.ru

ZAVOD GORELTEX, office 207, ul. Postysheva, 22A,
Khabarovsk, 680000, RUSSIA

REPUBLIC OF KAZAKHSTAN, ALMATY
Office and manufacturing site
ex@goreltex.kz kaz@goreltex.kz

ZAVOD GORELTEX, angar 18, Mkr. Kajrat 282,
Almaty, 050019, KAZAKHSTAN

REPUBLIC OF BELARUS, MINSK
Office
mail@goreltex.by

ZAVOD GORELTEX, office 13, Shafarnyanskaya ul.,
11, Minsk, 220125, BELARUS

UKRAINE, KIEV
Office
dir1@ext.com.ua

ZAVOD GORELTEX, of. 301, ul. Kirillovskaya 102,
Kiev, 04080, UKRAINE

mail@exd.ru
www.exd.ru